

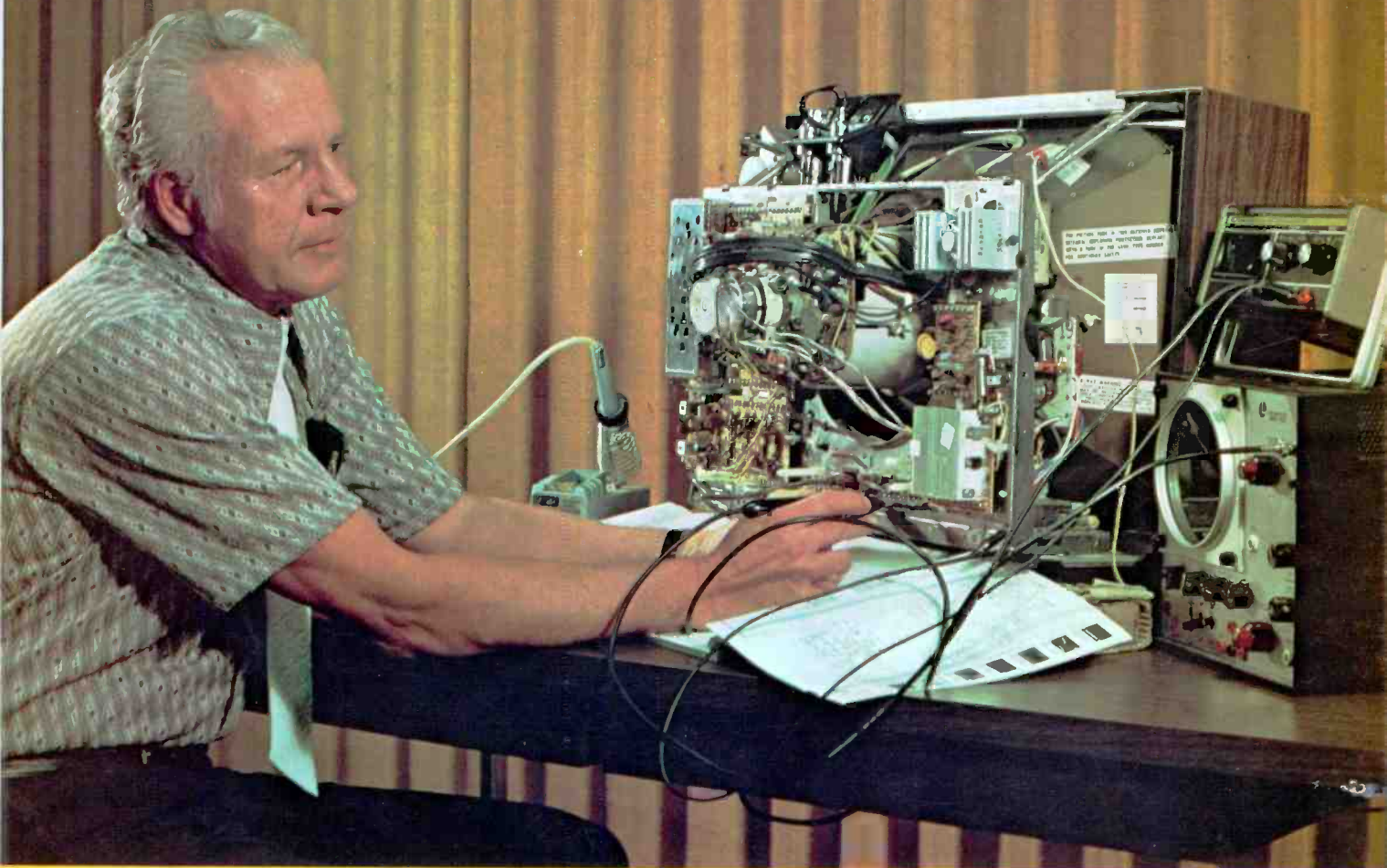
February, 1975 □ 75 cents

# Electronic Servicing



A HOWARD W. SAM'S PUBLICATION

## Servicing modular color



**Cassette Or Machine?  
Interlace Scanning Revisited**

ES1-275 R 4C 1277 4  
RICHARD B FONES JR  
25 BALTIMORE-ANNAPOLIS

# PTS ELECTRONICS

## Precision Tuner Service



now available near you

<b>ALABAMA</b> PTS ELECTRONICS 524 22ND ST. SOUTH BIRMINGHAM, ALA. 35222 TEL. 205. 323-2647	<b>CALIFORNIA—NORTH:</b> PTS ELECTRONICS 4611 HUBURN BLVD. SACRAMENTO, CALIF. 95841 TEL. 916. 482-6220	<b>CALIFORNIA—SOUTH:</b> PTS ELECTRONICS 5117 UNIVERSITY AVE. SAN DIEGO, CALIF. 92105 TEL. 714. 280-7070	<b>COLORADO:</b> PTS ELECTRONICS 4898 ALLISON ST. ARVADA, COLO. 80001 TEL. 303. 423-7080	<b>FLORIDA—NORTH:</b> PTS ELECTRONICS 12934 N.W. 7TH AVE. MIAMI, FLA. 33168 TEL. 305. 685-9811	<b>FLORIDA—SOUTH:</b> PTS ELECTRONICS 1918 BLANDING BLVD. JACKSONVILLE, FLA. 32210 TEL. 904. 389-9952	<b>HOME OFFICE—INDIANA:</b> PTS ELECTRONICS 5233 S. HWY. 37 BLOOMINGTON, IND. 47401 TEL. 812. 824-9331	<b>KANSAS:</b> PTS ELECTRONICS 3115 MERIAM LANE KANSAS CITY, KANSAS 66100 TEL. 913. 831-1222
<b>TEXAS—EAST:</b> PTS ELECTRONICS 4324-26 TELEPHONE RD. HOUSTON, TEX. 77032 TEL. 713. 644-6793						<b>LOUISIANA:</b> PTS ELECTRONICS 2914 WYCKWOOD DRIVE METAIRIE, LOUISIANA TEL. 504. 885-2349	
<b>TEXAS—NORTH:</b> PTS ELECTRONICS MOPAC LANE LONGVIEW, TEX. 75601 TEL. 214. 753-4334						<b>MARYLAND:</b> PTS ELECTRONICS 1105 SPRING ST. SILVER SPRING, MD. 20910 TEL. 301. 565-0025	
<b>TENNESSEE:</b> PTS ELECTRONICS 3614 LAMAR AVE. MEMPHIS, TENN. 38118 TEL. 901. 365-1918						<b>MASSACHUSETTS:</b> PTS ELECTRONICS 191 CHESTNUT ST. SPRINGFIELD, MASS. 01103 TEL. 413. 734-2737	
<b>PENNSYLVANIA—WEST:</b> PTS ELECTRONICS 257 RIVERVIEW AVE. W. PITTSBURGH, PA. 15202 TEL. 412. 761-7648						<b>MICHIGAN:</b> PTS ELECTRONICS 13709 W. EIGHT MILE RD. DETROIT, MICH. 48235 TEL. 313. 862-1783	
<b>PENNSYLVANIA—EAST:</b> PTS ELECTRONICS 1921 S. 70TH ST. PHILADELPHIA, PA. 19142 TEL. 215. 724-0999						<b>MINNESOTA:</b> PTS ELECTRONICS 815 W. LAKE ST. MINNEAPOLIS, MINN. 55408 TEL. 612. 824-2333	
<b>OREGON:</b> PTS ELECTRONICS 5220 N.E. SANDY BLVD. PORTLAND, OREGON 97213 TEL. 503. 282-9636	<b>OKLAHOMA:</b> PTS ELECTRONICS 3007 N. MAY OKLAHOMA CITY, OKLA. 73106 TEL. 405. 947-2013	<b>OHIO—SOUTH:</b> US TUNER SERVICE 8180 WINE ST. CINCINNATI, OHIO 45215 TEL. 513. 821-2298	<b>OHIO:</b> PTS ELECTRONICS 5682 STATE RD. CLEVELAND, OHIO 44134 TEL. 216. 845-4480	<b>NORTH CAROLINA:</b> PTS ELECTRONICS 724 SINGLE AVE. CHARLOTTE, N.C. 28205 TEL. 704. 332-8007	<b>NEW YORK CITY—NEW JERSEY:</b> PTS ELECTRONICS 158 MARKET ST. E. PATERSON, N.J. 07407 TEL. 201. 791-6380	<b>NEW YORK:</b> PTS ELECTRONICS 993 SYCAMORE ST. BUFFALO, N.Y. 14212 TEL. 716. 891-4935	<b>MISSOURI:</b> PTS ELECTRONICS 8456 PAGE BLVD. ST. LOUIS, MO. 63130

## LET US TAKE CARE OF YOUR TUNER PROBLEMS...

PTS will repair any tuner - no matter how old or new - black & white or color - transistor or tubes - varactor or electronically tuned - detent UHF. 8 hour service is a must!

### ...THIS IS THE SERVICE WE OFFER:

1. **Fastest Service**—8 hour—in and out the same day. Overnight transit to one of our strategically located plants.
2. **Best Quality**—Your customers are satisfied and you are not bothered with returning tuners for rework.
3. **PTS uses only ORIGINAL PARTS!** No homemade or make-do, inferior merchandise (this is why we charge for major parts!). You get your tuner back in ORIGINAL EQUIPMENT condition.
4. **PTS is recommended by more TV Manufacturers than any other tuner company.**
5. **PTS is overhauling more tuners than all other tuner services combined.**



**Fast 8 hr. Service!**

**We offer you finer, faster...**

## 1 YEAR GUARANTEE

VHF, UHF \$10.95  
 UV-COMBO 17.95  
 IF-SUBCHASSIS 12.50  
 Major parts and shipping charged at cost. (Dealer net!)

Over 4000 exact tuner replacements available for \$14.95 up (new or rebuilt).

# ...Precision Tuner Service



**ELECTRONICS, INC....**

**...Number ONE and still trying harder!**  
 (Not a Franchise Company)

For More Details Circle (11) on Reply Card

# Your sure-fire smoke detector is here...the Mallory SDA3 Alarm.

Automatically, 'round the clock, when hazardous smoke fumes threaten, it sounds a life-saving intermittent blast—so loud it can break through the deepest sleep.

The Mallory Smoke Detector Alarm is completely self-contained, battery-powered. It installs easily on ceilings—in hallways, bedrooms, wherever warning for escape from lethal combustion products (visible or invisible) is needed.

And the 12.6-volt Mallory battery is specially designed for added security. It changes characteristics after a life of approximately one year and the Alarm then emits a burst of sound at one-minute intervals, signaling that a fresh battery is needed.

All for a price so affordable, every home, apartment, trailer, office can have sure-fire smoke-alarm protection.

For details, see your Mallory distributor.



The SDA3 Alarm is compact, unobtrusive—only 6" x 1 $\frac{9}{16}$ ".

## MALLORY

**MALLORY DISTRIBUTOR PRODUCTS COMPANY**

a division of P. R. MALLORY & CO. INC.

Box 1284, Indianapolis, Indiana 46206; Telephone: 317-856-3731

Batteries • Capacitors • Controls • Security Products • DLRTAPE® • Resistors • Semiconductors • SONALERT® • Switches • Timing Devices and Motors  
DURACELL®, DURATAPE® and SONALERT® are registered trademarks of P. R. Mallory & Co. Inc.

For More Details Circle (4) on Reply Card

# electronicscanner

news of the industry

---

According to John J. Nevin, president of Zenith Radio Corporation, the television industry will benefit dramatically and immediately as the economy recovers. **Home Furnishings Daily** reports Nevin is optimistic, and anticipates a severe but relatively short recession.

A lawsuit against a TV repairman in Philadelphia has resulted from an investigation by the Pennsylvania Bureau of Consumer Protection. According to **Home Furnishings Daily**, the study has included "test shopping" by investigators who take altered TV sets to repair shops, then determine if the sets were properly repaired. The crackdown on unnecessary and deceptive repairs is expected to result in several lawsuits.

Electronic specialty items have found a common home in department stores throughout the U.S., reports **Home Furnishings Daily**. Calculators, digital watches, and telephone accessories are a few of the items that have been difficult for managers to place in the appropriate department. A popular reason for forming separate electronics departments is that an increasing number of salesmen for these products have strong electronic backgrounds.

Two service-dealer groups have joined forces to form a 300-member organization, said to be the largest independent group of its kind in the U.S. Metropolitan Electronic Television Service Dealers Association (METSDA) and Independent Appliance Service Association voted unanimously to join together. **Home Furnishings Daily** says the new group in New York will continue to use the METSDA name.

Two energy-saving features are introduced by Sanyo in Model 21T59, a solid-state 12-inch set. Only 30 watts of power are consumed, and the new picture tube gives a picture within seconds after turn-on. No power is drawn when the set is turned off.

RCA scientists have developed a technique using liquid crystals to observe electron pulses flowing through a tiny integrated circuit. With the new technique, scientists can locate operational defects by observing where electron flow is interrupted. The normally-clear liquid crystals reflect light when "stimulated" by electricity, reports **Radio & Television Weekly**.

A precision-inserting robot with tactile sensors is now at work on a production line doing delicate operations in assembling small electric motors. Developed by Hitachi, the robot features improved tactile-control technology. A flexibly-constructed wrist equipped with a tactile sensor permits shock-free insertion.

Motorola will terminate production of b/w TV sets by 1975, reports **Home Furnishings Daily**. Motorola sold its Quasar consumer products division to Matsushita Electric Industrial early in 1974, and will sell its monochrome

*(Continued on page 6)*

---

# TUNER SERVICE CORPORATION

**SUBSTITUNER**

INTRODUCING  
AT JUST

**\$39.95**  
U.S.A. ONLY

WITH CABLES



ONE YEAR  
GUARANTEE

STILL ONLY

**\$9.95**  
U.S.A. ONLY

ALL PARTS  
INCLUDED

EXCEPT TUBES  
AND TRANSISTORS



PROVIDES YOU WITH A COMPLETE SERVICE  
FOR ALL YOUR TELEVISION TUNER REQUIREMENTS.

## FEATURES

- A UHF Tuner with 70 channels which are detented and indicated just like VHF channels.
- A VHF Hi Gain Solid State Tuner.

Demonstrate the **SUBSTITUNER** to your customers and show improved reception with their TV sets.

You may place your order through any of the Centers listed below.

## REPAIR

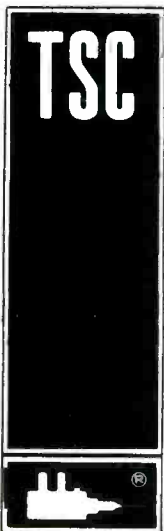
- VHF OR UHF ANY TYPE ..... (U.S.A. ONLY) \$ 9.95
- UHF/VHF COMBINATION .....(U.S.A. ONLY) \$15.00
- IN THIS PRICE ALL PARTS ARE INCLUDED. Tubes, transistors, diodes, and nuvistors are charged extra. This price does not include mutilated tuners.
- Fast, efficient service at our conveniently located Service Centers.
- All tuners are ultrasonically cleaned, repaired, realigned, and air tested.

## REPLACE

- UNIVERSAL REPLACEMENT TUNER \$12.95 (Canada \$15.95)
- This price buys you a complete new tuner built specifically by Sarkes Tarzian Inc. for this purpose.
- All shafts have a maximum length of 10½" which can be cut to 1½".
- Specify heater type parallel and series 450 mA. or 600 mA.

## CUSTOMIZE

- Customized tuners are available at a cost of only \$15.95. With trade-in \$13.95. (Canada \$17.95 and \$15.95)
- Send in your original tuner for comparison purposes to Franchises listed below.



HEADQUARTERS	BLOOMINGTON, INDIANA 47401	537 South Walnut Street	Tel. 812-334-0411
ARIZONA	TUCSON, ARIZONA 85710	P.O. Box 4534, 1528 S. 6th St.	Tel. 602-791-9243
CALIFORNIA	NORTH HOLLYWOOD, CALIF. 91601	10654 Magnolia Boulevard	Tel. 213-769-2720
	BURLINGAME, CALIF. 94010	1324 Marsten Road	Tel. 415-347-5728
	MODESTO, CALIF. 95351	123 Phoenix Avenue	Tel. 209-552-8051
FLORIDA	TAMPA, FLORIDA 33606	1505 Cypress Street	Tel. 813-253-0324
	HIALEAH, FLORIDA 33013	906 East 25th Street	Tel. 305-836-7078
GEORGIA	ATLANTA, GEORGIA 30310	938 Gordon Street S.W.	Tel. 404-758-2232
ILLINOIS	CHAMPAIGN, ILLINOIS 61820	405 East University Street	Tel. 217-356-6400
	CHICAGO, ILLINOIS 60621	737 West 55th Street	Tel. 312-873-5556-7
	SKOK E, ILLINOIS 60076	5110 West Brown Street	Tel. 312-675-0230
INDIANA	HAMMOND, INDIANA 46323	6833 Grand Avenue	Tel. 219-845-2676
	INDIANAPOLIS, INDIANA 46204	112 West St. Clair Street	Tel. 317-632-3493
KENTUCKY	LOUISVILLE, KENTUCKY 40208	2920 Taylor Boulevard	Tel. 502-634-3334
LOUISIANA	SHREVEPORT, LOUISIANA 71104	3025 Highland Avenue	Tel. 318-861-7745
MARYLAND	BALTIMORE, MARYLAND 21215	5505 Reisterstown Rd., Box 2654	Tel. 410-358-1186
MISSOURI	ST. LOUIS, MISSOURI 63132	10530 Page Avenue	Tel. 314-429-0633
NEVADA	LAS VEGAS, NEVADA 89102	1412 Western Avenue No. 1	Tel. 702-384-4235
NEW JERSEY	TRENTON, NEW JERSEY 08638	901 North Olden Avenue	Tel. 609-393-0999
	JERSEY CITY, NEW JERSEY 07307	547-49 Tonnetle Ave., Hwy. 1 & 9	Tel. 201-792-3730
OHIO	CINCINNATI, OHIO 45216	7450 Vine Street	Tel. 513-821-5080
	CLEVELAND, OHIO 44109	4525 Pearl Road	Tel. 216-741-2314
OREGON	PORTLAND, OREGON 97210	1732 N.W. 25th Avenue	Tel. 503-222-9059
TENNESSEE	GREENEVILLE, TENNESSEE 37743	1215 Snapps Ferry Road	Tel. 615-639-8451
	MEMPHIS, TENNESSEE 38111	3158 Barron Avenue	Tel. 901-458-2355
TEXAS	DALLAS, TEXAS 75218	11540 Garland Road	Tel. 214-327-8413
VIRGINIA	NORFOLK, VIRGINIA 23513	3295 Santos Street	Tel. 804-855-2518
CANADA	ST. LAURENT, QUEBEC H4N-2L7	305 Decarie Boulevard	Tel. 514-748-8803
	CALGARY, ALBERTA T2H-0L1	448 42nd Avenue S.E.	Tel. 403-243-0971
		P.O. Box 5823, Stn. "A"	

WATCH US  
GROW

IF YOU WANT TO BRANCH OUT INTO THE TV TUNER REPAIR BUSINESS,  
WRITE TO THE BLOOMINGTON HEADQUARTERS ABOUT A FRANCHISE.

For More Details Circle (5) on Reply Card  
[www.americanradiohistory.com](http://www.americanradiohistory.com)

(Continued from page 4)

production to Oak Industries, Crystal Lake, Illinois.

**Zenith and RCA modules can receive one-day repairs** at the Bloomington branch of PTS Electronics, Incorporated. Roland F. Nobis, president of PTS Electronics, revealed that a pilot project on module repairs has been in operation for the past year. Address of the branch making module repairs is: PTS Electronics, P.O. Box 272, Bloomington, Indiana 47401.

**Dr. Robert Adler, vice-president of research for Zenith Radio Corporation,** recently received the outstanding-technical-paper award from the Chicago Section of the Institute of Electrical and Electronics Engineers (IEEE). The award-winning paper was titled "An Optical Video Disc Player for NTSC Receivers", and it reported the results of a Zenith research-and-engineering team effort to develop an optical video disc player based on a thin flexible disc, and the aerodynamic disc stabilizer developed by a similar team at the Central Research Laboratory of Thomson-CSF in France. The video-disc playback system is said to be the "record player of the future", and is designed to play color pictures with sound through a color TV receiver.

**RCA will reduce its one-year warranty on all solid-state color TV and monochrome sets to 90 days** with the introduction of its new lines in the spring. Reasons for the reduction, according to reports in **Home Furnishings Daily**, are escalating costs for labor and administration of the one-year warranty. Roy Pollack, RCA vice-president, said another reason for the change is that solid-state sets have established their reliability and gained consumer acceptance. The RCA move might lead the way for other TV manufacturers to make comparable reductions.

**A massive recall of TV sets might result from action taken by the U.S. Bureau of Radiological Health.** According to **Home Furnishings Daily**, recall orders for 300,000 TV sets manufactured in the past 3 years by Matsushita have been issued, claiming that excessive radiation emissions could result from failure of certain components in the sets. Even though the Panasonic, Penncrest, and Bradford label sets appear to operate normally when the component fails, the result could be emissions 5- to 25-times above maximum limits allowed by Federal standards. Corrective action plans are being processed. Magnavox has recalled six models of 19-inch monochrome sets that contain a possible fire hazard. The model numbers are: ME5140, ME5141, ME5142, MD5140, MD5141, and MD5142. The defect is a possible loose connection that could cause an electrical arc.

**U.S. News & World Report subscribers** responding to a survey designed to assess consumer interest in future purchasing of video-tape camera-recorder systems, indicated most would be interested in buying at a median price of \$528.00. A companion survey of a U.S. population sample indicated buying interest at a close median price of \$525.00. □

---



**FREE** from your Winegard distributor:  
**New 'BIZ BOOMER UPPER KIT'**  
 gives you 15 ways to put more  
 ring in your register...  
 more profit in your picture in '75.

**Antenna sales slipping?** Profits sliding? We can give you some timely, tested, proved effective help. A special Biz Boomer-Upper Kit with 15 sales-getter ideas and the materials you need to put 'em in action.

The kit's yours at no cost from your Winegard distributor. Designed so that *together* you can launch a planned program to sell replacements for all those tired old weather-beaten or damaged an-

tennas on homes in your area.

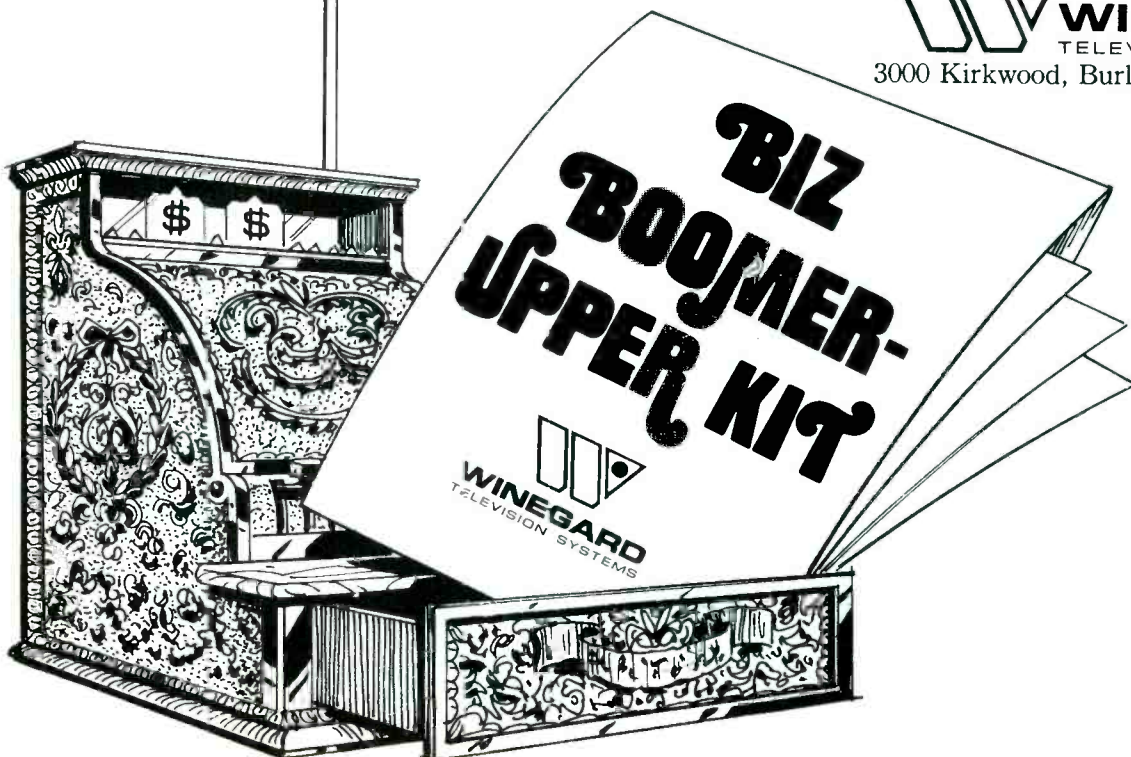
In today's competitive climate, this could be the extra promotion power you need to push profits up to—or ahead of last year's. Definitely, an offer you shouldn't refuse.

Not yet in the antenna business? There's plenty of potential going unsold right now. And your Winegard distributor can help you cash in. Why not contact him—today.

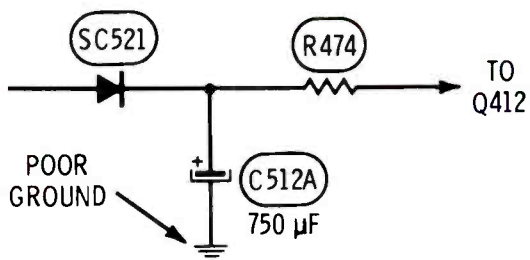


**WINEGARD**  
 TELEVISION SYSTEMS

3000 Kirkwood, Burlington, Iowa 52601

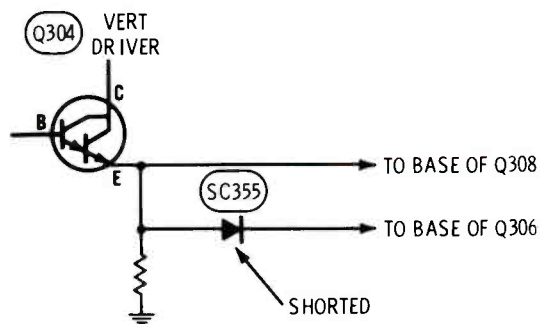


Chassis—Sylvania EO3  
PHOTOFACT—1414-3



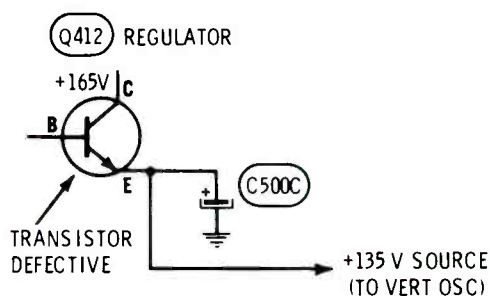
**Symptom**—Heavy hum bars in picture  
**Cure**—Check for a poor ground at C512A

Chassis—Sylvania EO3  
PHOTOFACT—1414-3



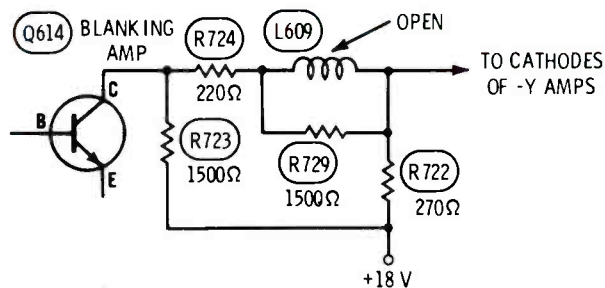
**Symptom**—No vertical sweep  
**Cure**—Check SC355, and replace it if shorted

Chassis—Sylvania EO3  
PHOTOFACT—1414-3



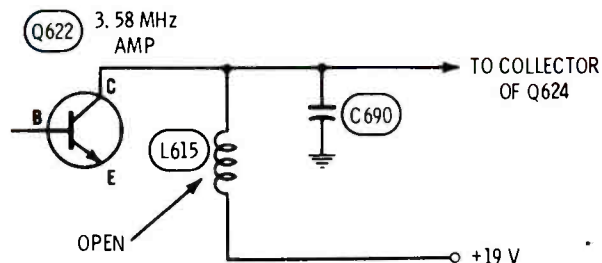
**Symptom**—Intermittent height  
**Cure**—Check Q412, and replace it if defective

Chassis—Sylvania D17  
PHOTOFACT—1288-3



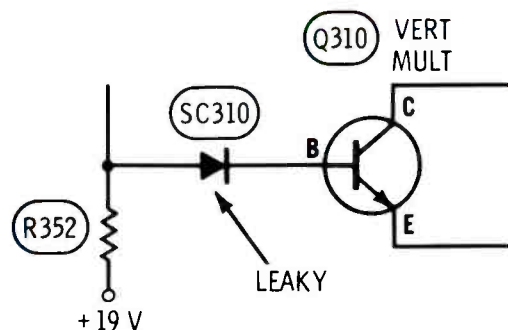
**Symptom**—Insufficient brightness; poor gray-scale tracking  
**Cure**—Check L609, and replace it if open

Chassis—Sylvania D17  
PHOTOFACT—1288-3



**Symptom**—No color  
**Cure**—Check L615, and replace it if open

Chassis—Sylvania D17  
PHOTOFACT—1288-3



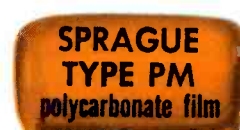
**Symptom**—Intermittent vertical locking  
**Cure**—Check SC310, and replace it if leaky



# Avoid serious trouble in color TV sets by using the right replacement capacitor!



This capacitor is **GREAT** for 90% of your film capacitor replacements. But . . . it's **NOT** designed for certain critical applications.



These capacitors are a **MUST** for critical commutating and S-shaping applications.

The next time you replace a dipped tubular in one of the newer color TV sets, don't automatically assume you're replacing an ordinary every-day film or paper capacitor. If it happens to be a deflection capacitor used for commutating or S-shaping, you need a polypropylene or polycarbonate film replacement with (1) high a-c current-carrying capability; (2) close capacitance tolerance; (3) good capacitance stability. The standard replacement

capacitors used in the industry, even our superior Type PS dipped tubulars, just won't do the job . . . and they could cause the set to become inoperative again.

Play it safe . . . dipped tubulars may look alike on the surface, but there can be a big difference in the film dielectric. Keep a supply of Sprague Type PP and PM capacitors on hand for those critical situations where ordinary replacements won't work.

## SPRAGUE TYPE PP POLYPROPYLENE FILM TYPE PM POLYCARBONATE FILM CAPACITORS

$\mu\text{F}$ @ WVDC	Cap. Tol.	D. x L.	Cat. No.	$\mu\text{F}$ @ WVDC	Cap. Tol.	D. x L.	Cat. No.
1.75 @ 100	$\pm 5\%$	.900 x 1.000	PM1-M1.75	.0039 @ 600	$\pm 5\%$	.400 x .800	PP6-D39S
1.5 @ 150	$\pm 5\%$	.800 x .937	PM15-M1.5	.01 @ 600	$\pm 5\%$	.500 x 1.250	PP6-S10S
.01 @ 400	$\pm 5\%$	.400 x .750	PP4-S10	.066 @ 600	$\pm 5\%$	.800 x 1.250	PP6-S66S
.015 @ 400	$\pm 5\%$	.450 x .750	PP4-S15	.075 @ 600	$\pm 5\%$	.750 x 1.250	PPS-S75S
.033 @ 400	$\pm 5\%$	.500 x .750	PP4-S33S	.022 @ 800	$\pm 3\%$	.600 x 1.300	PP8-S22S
.06 @ 400	$\pm 5\%$	.800 x 1.250	PP4-S60S	.047 @ 800	$\pm 5\%$	.700 x 1.250	PP8-S47S
.081 @ 400	$\pm 2\%$	.600 x 1.300	PP4-S81S	.051 @ 800	$\pm 5\%$	.800 x 1.250	PP8-S51S
.2 @ 400	$\pm 5\%$	.700 x 1.700	PP4-P20	.0018 @ 1600	$\pm 5\%$	.500 x 1.300	PP16-D18
.0018 @ 600	$\pm 5\%$	.400 x .750	PP6-D18S	.002 @ 1600	$\pm 5\%$	.500 x 1.300	PP16-D20
.0022 @ 600	$\pm 5\%$	.400 x .750	PP6-D22S	.0033 @ 1600	$\pm 5\%$	.550 x 1.300	PP16-D33
				.0039 @ 1600	$\pm 5\%$	.600 x 1.300	PP16-D39

For cross-reference information on close-tolerance polypropylene and polycarbonate film capacitors, showing original part numbers with correct Sprague replacements, ask your Sprague distributor for Cross-Reference Guide C-873, or write to: Sprague Products Company, 105 Marshall Street, North Adams, Mass. 01247.

**THE BROAD-LINE PRODUCER OF ELECTRONIC PARTS**



# troubleshootingtips

Send in your helpful tips—we pay!

## No blue in raster Philco 3CR40 color chassis (Photofact 1366-1)

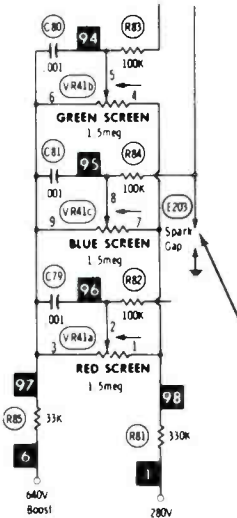
There was no blue in the picture, making everything greenish-yellow on b-w and causing wrong colors on colorcasts.

When I turned up the blue screen in an effort to obtain more blue, the brightness of red and green dropped off, and the height was decreased. Evidently something was loading the B-boost, because it measured only about 200 volts when the blue screen was turned high.

B-boost measured the same with the socket of the CRT removed, and this eliminated the picture tube from suspicion.

The only parts remaining to be tested were the blue screen control, VR41C, C81, R84, and the spark gap. (Some runs of this chassis have spark gaps at all three screens.) When I clipped the spark gap, the

blue returned in full force. As insurance, I also replaced C81 and



R84 when I installed a new spark gap (Philco part 30-4712-5).

Dick Reynolds  
Beacon, New York

## Testing gain of stereo channels Any stereo tape player

It's good technique to compare the gain of a good channel with the bad one in stereo tape players. The problem is in finding a good source of signal.

One easy way is to radiate 60 Hz from a head demagnetizer placed about four inches from the head. At this distance, the hum signal is strong enough for good testing without being excessive and causing overload.

Caution: don't operate the demagnetizer longer than about five minutes; most run warm when operated continuously. After you locate the stage that has the defect, use voltage readings and other methods to find the bad part.

Stan Telson  
Tucson, Arizona

Had a funny  
experience lately?  
Send details  
to Reader's Chuckles

# New generation Flat rate pricing...

...truly outdates old methods ... prices your work realistically!

Still using the old single flat rate charge for house calls or bench work regardless of repair time required? You may say it all averages out. But, how strongly do your customers feel about consumerism and TV exposés? You could be leaving yourself wide open for trouble...big trouble!

This is where **Tech's Guide to Pricing** comes in ... the "New Generation" of flat rate pricing ... the system that breaks down each repair step or adjustment encountered. Keeps a true and proper balance between cost and work performed in the eyes of the consumer.

**Tech's Guide** is in a professional, hard-use cover. 6-ring steel binding, fast-tab design, 7½x9½ size fits in the tool box ... ready for immediate use. Calculator adjusts in seconds for any area in the U.S. ... it's the new industry standard. Relieves you of the stress and pressure of pricing responsibility! Simply fill out the coupon, include check or money order. All orders filled same day.



tv & radio  
**tech's guide  
to pricing**

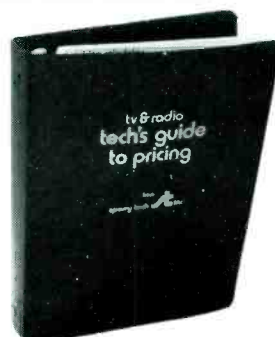
\$18<sup>00</sup>  
per issue,  
postpaid.

(Nebr. residents add city and state sales tax)

**sperry tech inc.**  
P.O. Box 5234  
Lincoln, NE. 68505

More information please.  
 My check or money order enclosed.

NAME \_\_\_\_\_  
COMPANY \_\_\_\_\_  
ADDRESS \_\_\_\_\_  
CITY \_\_\_\_\_ STATE \_\_\_\_\_ ZIP \_\_\_\_\_



For More Details Circle (26) on Reply Card

# Techniques for servicing modular color

## Part 1



By Charles D. Simmons

Some informed sources say that solid-state television receivers have about 35% fewer repairs than tube versions have. But when a solid-state set does give trouble, the problem can be king-sized (including strings of burned-out transistors and IC's). Modular construction helps by allowing easy removal of many components. Even so, you must use care to be sure of finding

the original cause of a failure, otherwise the replacements might be ruined.

Yes, servicing solid-state modular color receivers is vastly different from the familiar methods we used with the older tube-powered sets. For one reason, there are few similarities of circuits used by the various manufacturers. Therefore, we will describe one chassis at a

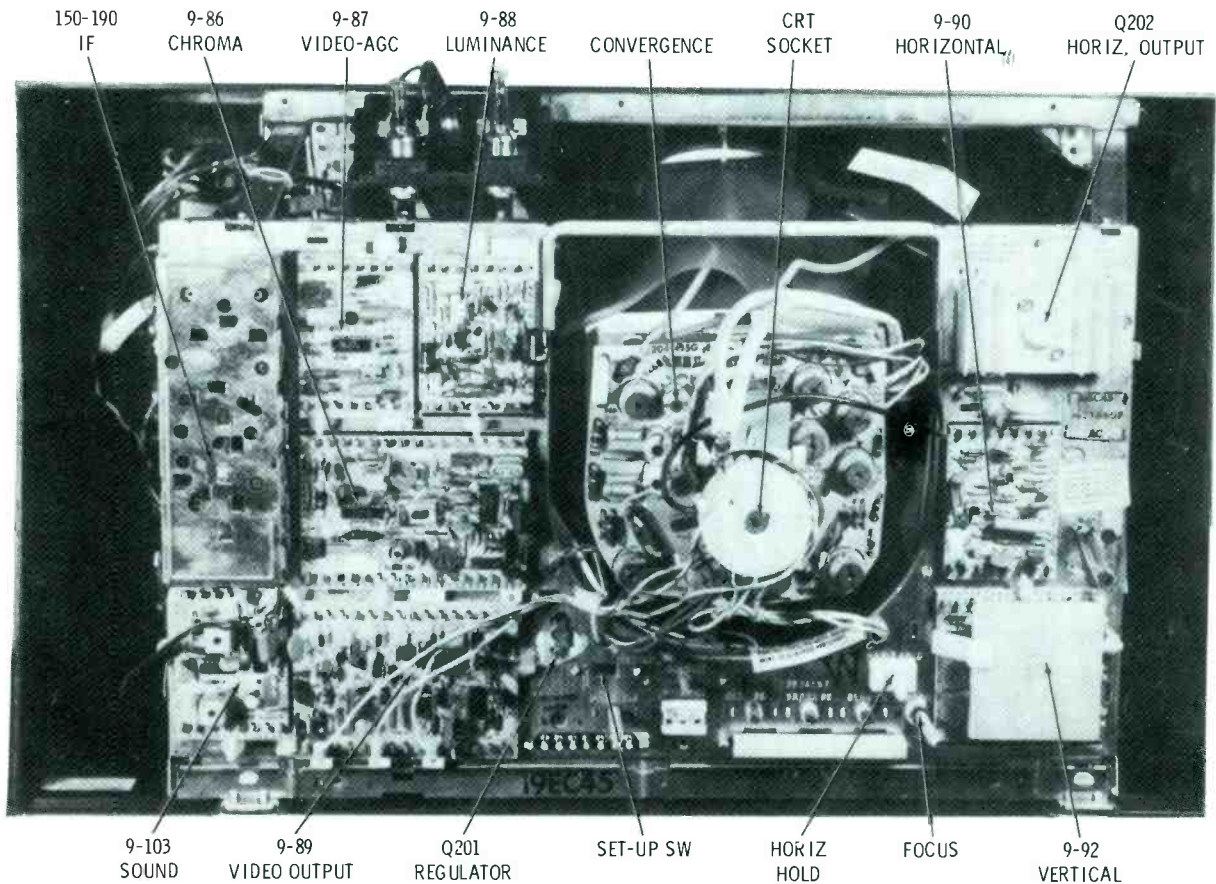


Fig. 1 Arrows point to locations of the modules and major components of a 19EC45 Zenith solid-state modular TV receiver.

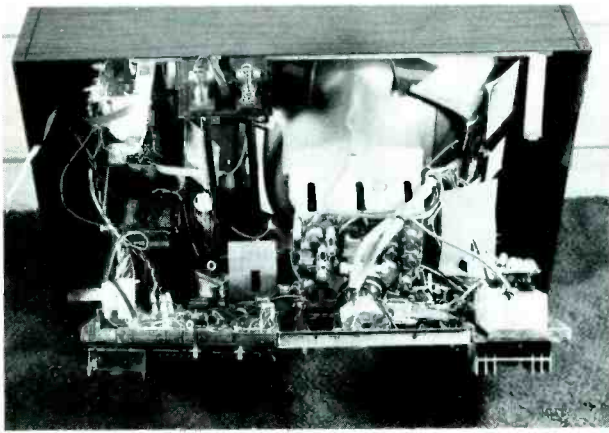


Fig. 2 After removal of a few screws, the vertical chassis can be tilted back at about a 45° angle, exposing the wiring on the backside and the power-supply components mounted on the horizontal chassis at the bottom.

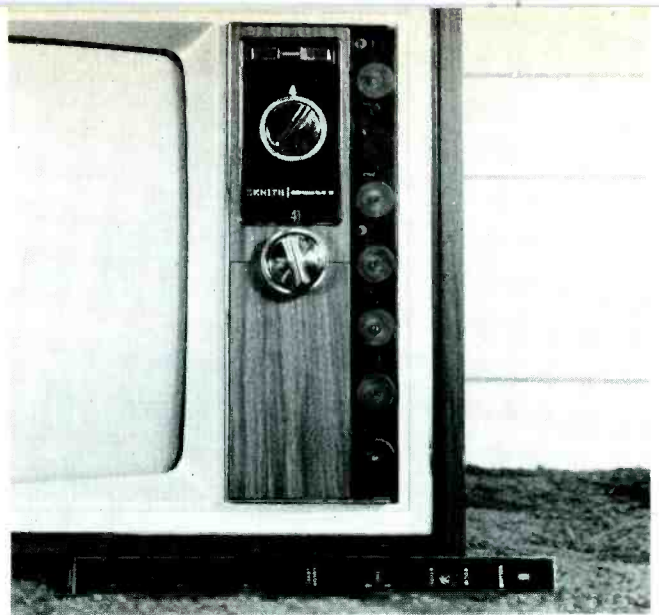


Fig. 3 Knobs for the operating controls are mounted vertically along the right side of the front panel. Remove two screws, and a trim panel comes out, exposing the preset control for Chromatic operation.

time until all the major brands are covered.

The next few articles will be about the vertical-chassis Zenith portable.

Introduced in the 1974 line, the 17EC45 and 19EC45 chassis were the first vertically-mounted solid-state modular chassis from Zenith. Except for the sound circuit, and a few other minor differences, the circuits are the same as those in the horizontal solid-state chassis of that year. Also, the 1975 versions (17FC45 and 19FC45) have been changed very little from the previous "EC" models.

There are many new and interesting circuits and features in these Zenith color receivers. In addition to facts about the four Zenith models, we also will discuss troubleshooting methods that are especially efficient for servicing modular receivers of all brands.

### General Description

Seven plug-in duramodules and one plug-in IF module contain about 80% of the active components, as shown in Figure 1. Convergence board and deflection yoke are built into one assembly fastened around the neck of the picture tube. Pincushion components also are placed there.

A most-important serviceability feature is that the chassis is hinged at the bottom so it can be tilted

backwards (after removal of a few screws) to about a 45° angle, exposing much of the back side of the chassis (Figure 2). The chassis can be operated in this position.

There are two other options for reaching the hidden corners. You can remove 4 screws, disconnect the cables, and lift out the chassis (without tuner cluster, picture tube and convergence panel). Or, if you want to operate it while it's open, remove 6 screws and the whole unitized chassis assembly comes out, along with the picture tube and tuner.

On the front panel, a "Chromatic" button switches to preset color controls, while the AFT is controlled by a separate button. A panel along the right side can be removed to expose the preset adjustments, if any changes are desired (Figure 3).

The picture tube is of the conventional delta-gun type (black-matrix type of screen) with high-voltage focus. Video and chroma signals are matrixed before reaching the cathodes of the picture tube.

### Interesting circuits

Multiple voltage regulation is furnished, first from a special voltage-regulating power transformer, and also by transistor regulation of the +24-volt supply.

Another circuit meriting extensive analysis is the direct-coupled

transformerless vertical-output stage. There are some precautions to be observed in troubleshooting, because if vertical sweep is lost, a fail-safe path back to the video blanks out all brightness.

There is no high-voltage regulation, as such. However, the inherent low voltage drop across the solid-state HV rectifier, regulation of the supply voltage to the horizontal-output transistor, and the action of the brightness-limiter circuit all combine to provide good HV regulation.

Horizontal locking is so tight that the control is mounted on the vertical chassis where it is accessible from the rear. In fact, it's difficult to throw the horizontal out of lock even when you try to do so.

The picture-tube socket looks rather large. That's because 1K resistors are in series with the grids, cathodes, screens, and focus anode. Also, each has a spark gap, with a single heavy-duty ground wire back to the chassis. These spark gaps are to protect the solid-state devices, which are extremely-susceptible to damage from arcs.

### General Modular Tips

Here are a few preliminary tips for servicing modular equipment:

- Don't remove or plug in modules when the power is turned on;
- Some models detour a power supply source through one or more

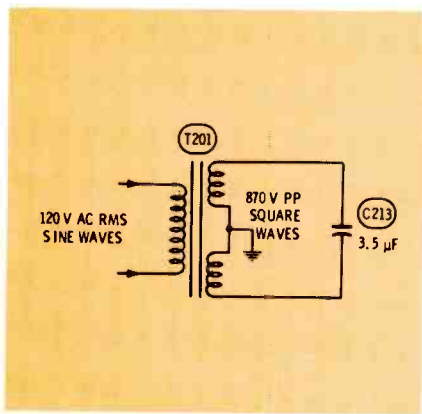


Fig. 4 Power transformer, T201, is built with loose coupling between primary and secondary windings, and arranged so the core around the primary does not saturate, but the core around the secondary does. Therefore, the secondary waveform is a clipped sine wave, or roughly a square wave, that varies little in amplitude with different primary voltages. C213 rounds the edges of the square wave and increases the p-p voltage.

modules as a kind of interlock. Therefore, such sets cannot be operated with the module removed for test;

- If a module has obviously burned or damaged components, you should check for the reason. Otherwise, the new module you try might be damaged, also;

- Be selective in the kind of chemicals you use on the plugs, edge-connectors and other terminals. Obey the manufacturers recommendations, when known; and

- Use extreme caution when connecting meter probes, or other test gear, to any modular terminal (but especially the solid-state devices). One split second short can blow a whole string of transistors or IC's. Use tiny clips or hooked grippers: turn off the power before attaching any clips, turn on the power only after the clip is secure and make the test, then turn off the power before disconnecting the clip.

It's not recommended that you merely touch a probe to the connection while the power is on; there's too much danger of slips causing short circuits.

More tips will be given later in the series.

### Voltage-Regulating Power Transformer

Most of the voltage regulation comes from the special design of the power transformer. Voltage-regulating transformers are not new, but most in the past used magnetic amplifiers making them large, heavy, costly, and having excessive heat. As shown in Figure 4, there is just one extra component used with the Zenith transformer, an oil-filled 3.5 microfarad capacitor rated at 450 volts AC RMS.

Actually, the capacitor is not part of the basic regulating action, but the power supplies are designed with it included. Without it there's

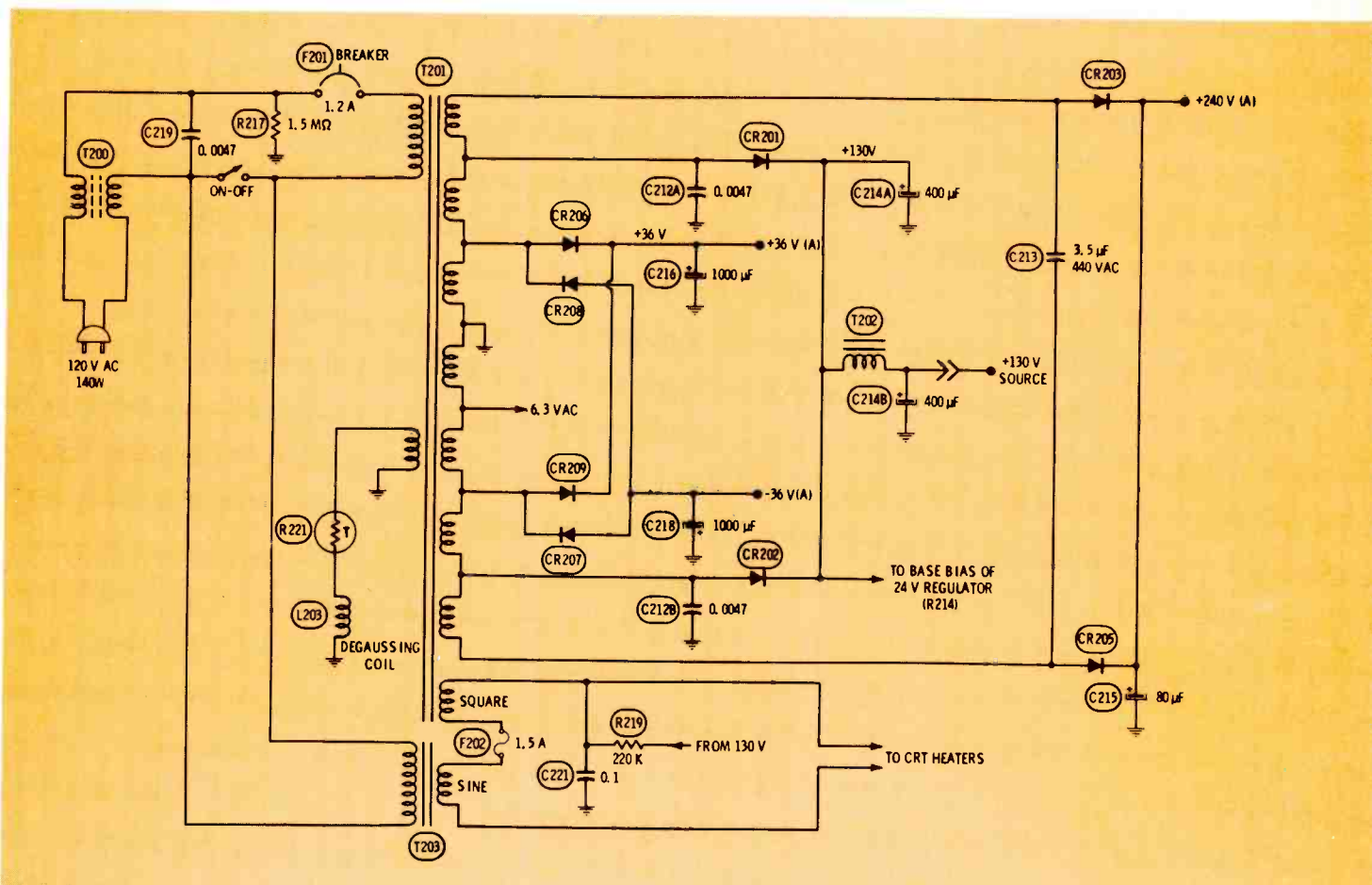


Fig. 5 This complete schematic of the power supply (less the 24-volt regulator) shows the unique CRT heater wiring, and the four rectifier circuits using eight diodes.

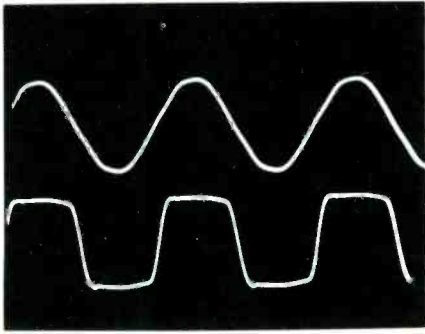


Fig. 6 The waveform at the top shows the 12.5 volt p-p sine wave signal applied to the heaters of the picture tube when the power switch is turned off. The square waves of the bottom trace are those applied to the CRT heaters when the power switch is turned on. Amplitude of the square waves also is 12.5 volts p-p, although the heating power is much greater than that of the sine waves. The partial power applied to the heaters, when the power is off to the rest of the set, allows a raster to be seen just seconds after the switch is turned on. **Caution:** don't turn set on and off by the power plug; the heater fuse might blow.

a large loss of voltage. Together, the capacitor and the transformer winding act as a low "Q" tuned circuit.

Briefly stated, regulation by the power transformer is accomplished by clipping sine waves into square waves. The core has less iron, and the primary and secondary windings are around the outside legs of the core (conventional transformers have all windings around the center leg). As the sine wave at the primary increases, the secondary voltage follows in step for a time. Then the core around the secondary saturates, and an increase of primary voltage doesn't increase the secondary voltage. So, **any** input voltage above the minimum gives about the same output voltage.

Core saturation does increase the transformer heat by about 20 degrees. However, the transformers are not prone to failure, because of a new type of coating for the wires, and the low-power requirements of the solid-state design. Zenith distributors report that failures of either the capacitor or the transformer are rare.

Although C213 does not contri-

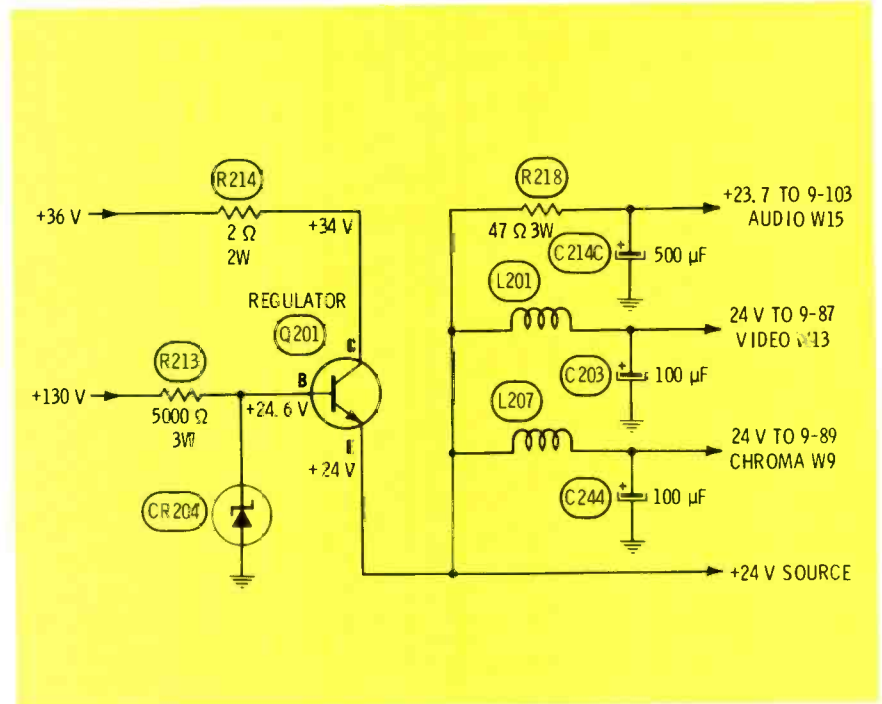


Fig. 7 The collector/emitter resistance of Q201 is used as a variable series resistance to regulate the 24-volt supply. Base voltage is clamped by the zener diode, CR204, so the emitter voltage determines the forward bias. Notice the many circuits powered from this source.

bute much to the regulation, it does increase the p-p secondary voltage by about 10%, removes most of the magnetic-switching transients, and reduces the amplitude of any noise riding in from the power line.

#### Waveform affects tests

Measurement of the square-wave secondary voltages can produce some wildly-inaccurate readings, unless you understand your meter. All of the older VTVM's (and many of the new solid-state meters) rectify both peaks and are calibrated in RMS, peak-to-peak, or both with separate scales. The p-p scales are fairly accurate regardless of signal waveshape; but the RMS calibrations are accurate only for sine waves.

(These differences of readings have nothing to do with the quality or brand of meter, but only depend on how the meter obtains an AC reading.)

Several reports have been received of technicians who followed a false trail of diagnosis when they measured the **normal** CRT heater voltage in one of these Zeniths and thought it wrong because the

reading was only 4.4 volts AC! **It was 4.4 volts RMS of square waves which have the same heating power as sine waves of 6.3 volts.**

To avoid confusion, we recommend you use a meter that reads all waveshapes accurately in peak-to-peak calibrations. In this case, the CRT heater should test around 12.5 volts p-p. That square wave voltage gives the same heating power as 17.8 volts p-p of sine waves.

#### Power Supply Details

The power supply (less regulator-transistor circuit) of the Zenith 19EC45 chassis seems rather complicated (Figure 5), but only because there are four separate full-wave DC supplies, each one having two silicon diodes. All of these components are mounted on the horizontal chassis at the bottom of the cabinet, and are reasonably accessible when the chassis is tilted back to the 45° position.

#### Fast CRT warmup

These chassis are all-solid-state and everything warms up ready for operation within a fraction of a second, except for the picture tube.

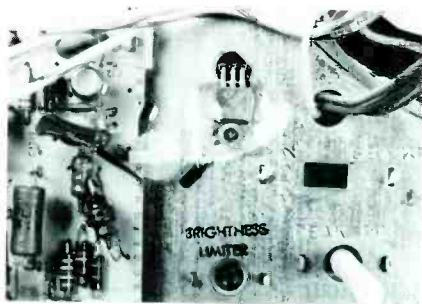


Fig. 8 Q201 regulator transistor is plugged into a socket just to the right of the video-output module. If you check DC voltages there, be extremely careful the probe doesn't slip and short two leads together. One split-second short blows the transistor. Use silicone heat-dissipating grease on both sides of the mica insulator that's between transistor and chassis, and bolt it solidly being careful not to crush the mica, if you replace Q201.

To make possible a picture almost instantly after turn-on, partial power is applied during the off time to the CRT heater. At turn-on, the voltage is increased to normal, and a picture can be seen in a few seconds. Someone has said that "instant-on" really means never completely off. There are many different variations of instant-on.

In the 19EC45 chassis, one unusual feature is that the waveform of the CRT heater voltage consists of sine waves with the power switch off, and square waves with the switch on. Can you imagine the feelings of a technician who didn't know that, but found it accidentally with his scope?

Waveforms and p-p readings of the two kinds of CRT heater voltages are given in Figure 6. Scope gain was not changed between the two exposures. The interesting coincidence is that the p-p voltage is nearly identical for the two waveforms! Of course, the square waves have more heating power.

Incidentally, the heater voltage is regulated when the power switch is on, but not when it is off. In the unlikely event the line voltage was very low (perhaps 70 volts), the warmup after turn-on might be slow.

Another point that affects trou-

ble-shooting is the way the CRT heater voltage is obtained from one winding of each of two separate transformers. When the power switch is on, the regulating power transformer (T201) supplies the heater voltage, but in series with the heater winding of T208 (shown below T201 in Figure 5). If you were to measure it, you would find some square-wave voltage across the winding of T208. Obviously, this can't come from the primary, because it's shorted by the on/off switch. Actually, that power comes from voltage drop produced by the DC resistance of the T208 winding. The voltage drop would be intolerably high, except the inductive effect is largely eliminated because the power switch shorts out the primary winding.

When the power switch is off (open) the situation is reversed somewhat. T208 has nearly full sine-wave line voltage at the primary. Although T201 primary is in series with it, the load of T201 is much greater than that of T208. Therefore, T208 gets almost all the voltage drop. The secondary winding of T208 supplies the CRT heaters, in series with the winding of T201. This current causes some voltage drop across the heater winding of T201, and by reverse transformer action would cause a small amount of DC voltage from the rectifiers, except the phase opposes that of the accidental voltage at the primary of T201.

Looking at it another way, each heater winding must supply more than is needed by the picture tube to make up for the series resistance of the other winding. That's a good reason to measure the voltages and waveforms at the CRT socket, and so avoid the confusion of two sources.

Have you noticed that this method of obtaining instant-on does not require any extra switch contacts? That's important to any technician who has encountered some of the weird symptoms brought about by defects in the extra switches and linkages of other systems.

#### Don't blow the fuse

You will notice a 1.5-ampere fuse in the schematic of Figure 5 be-

tween the heater winding of T201 and the winding of T208. A 1.5 amp rating is low enough for protection and high enough to prevent nuisance failures when there's no defect. At least that is true, if the power cable is left connected to the outlet at all times, and the set is turned on and off with the power switch. When the heater has partial power with the switch off, there is only a small extra surge of current when the switch is turned on and the heater receives full power. The fuse does not blow.

But suppose the power cable has been unplugged, and the switch left at the on position. When next the cable is plugged in, the large rush of current through the cold heater probably will blow the fuse. Then the symptom is "sound, but no picture or raster".

Later-production chassis come equipped with a 2 ampere fuse.

#### No Instant-on In 1975's

Power supply circuits of the 1975 17FC45 and 19FC45 chassis are nearly the same, except the heater fuse now is 4 amperes and there is no extra transformer to keep the CRT heaters warm at all times. Instead, the picture tube has a special fast-heating cathode that supplies a raster within fifteen to eighteen seconds after turn-on. Instant-on has become a casualty of the energy crisis.

#### 24-Volt Regulation

Figure 7 shows the 24-volt regulator schematic. Collector voltage comes from the +36-volt supply. Base voltage of Q201 is clamped by R213 and the zener diode, CR204. The variable emitter voltage relative to the constant base voltage determines the forward bias, and thus the resistivity.

The principle of using an emitter resistor to stabilize transistor current is used here to regulate the 24-volt supply at the emitter of Q201. If the emitter DC voltage rises, the increase is subtracted from the base/emitter forward bias. Therefore, the collector/emitter resistance increases, and the additional series resistance drops the emitter voltage (24-volt supply) back nearly to the original voltage.

Of course, if a heavier drain drops the 24-volt supply voltage, the forward bias is increased, decreasing the collector/emitter resistance, and bringing the emitter voltage almost up to the original value.

Physically, Q201 is plugged into a socket, the leads are bent at a 90° angle, and the transistor is bolted to the chassis just to the right of the video-output module, as shown in Figure 8.

### Automatic Degaussing

A separate winding of T201, the regulating transformer, feeds AC voltage to the thermistor (R221), through the degaussing coil and to ground. When the power switch is off, there is no voltage across R221 so it is cold and low in resistance.

Immediately after turn-on, a large current flows through R221 and the degaussing coil. The current heats R221 causing it to increase in resistance (decreasing the current through the degaussing coil). Finally a point is reached where the current is virtually zero, and all the voltage is across the thermistor, which now has a very-high resistance. These conditions remain until the power is turned off, the thermistor cools, and the cycle is ready to go again.

The circuit thus fulfills the requirements that the degaussing current must have a symmetrical waveform, and that the current start large and gradually taper off to zero.

### Troubleshooting The Power Supplies

With four separate rectifier circuits, and two kinds of voltage regulation, power-supply troubleshooting in these sets could get complicated. If we attempt to service these power sources by guess, we are in big trouble. But if we understand the theory of power supplies, and take a little time to diagnose the symptoms, none of the problems should be particularly difficult.

For example, suppose the picture is small on all four sides (Figure 9). In a tube set, a first diagnosis might be of a low B+ supply. Secondly, the horizontal sweep might be weak and reducing the vertical height because the oscillator is supplied from the B-boost. Well, in this chassis the vertical oscillator is **not** run from B-boost, so it's not likely to involve the horizontal sweep at all.

That brings the diagnosis right back to power supplies again. A search of the complete schematic reveals that both the height control and the horizontal output transistor receive power from the same +130-volt supply. This voltage is found easily at the white wire to the flyback transformer. A VTVM and the work of a moment prove the +130-volt supply has only +105 volts. A quick cross check of the

+24 supply shows it is okay; therefore, the problem is confined to the +130 supply.

**Or is it?** Remember, the +24-volt supply is transistor regulated, and that might be hiding a more-general power supply deficiency.

From the first part of the article, we know that an open C213 (that is across the entire secondary of the regulating transformer) would reduce the p-p voltage at the secondary by about 10%. But the +130 supply is about 20% low. Could an open C213 cause that much change of DC?

### Waveform offers proof

If you suspect an electrolytic type of filter of being open, you just parallel it with another. Elimination of the trouble is proof enough that the old capacitor is open. That won't work with C213, because it is an AC type. It's likely an electrolytic would explode in seconds if bridged across C213.

But there is an easy test that's accurate and foolproof. Just check the waveform across the terminals of C213. Figure 10 shows the correct waveform with a good capacitance, and the waveform produced by an open C213. Not only is the p-p amplitude reduced, but the flat tops and bottoms are narrowed when the capacitor is open. The narrowed tops and bottoms probably account for the extra 10% loss of DC in excess of the 10% reduction of p-p amplitude.

Of course, an open C213 would reduce the DC voltage of the other supplies which are not regulated except by the transformer. There is no way the transformer itself can lose the ability to regulate.

### Low line voltage

The individual 19EC45 chassis I tested retained a full raster size down to 75 volts of line voltage. At 60 volts, the picture was small just as it was when C213 was open. Below that level (about 50 volts), the picture got darker and smaller and developed severe 120-Hz hum symptoms. The reason for the hum



Fig. 9 A small picture, both vertically and horizontally, results from an open C213, or a line voltage of only about 70 volts RMS.

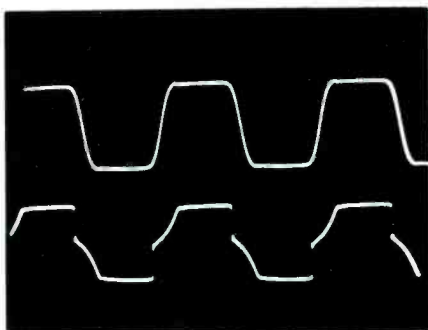


Fig. 10 Waveform at the top is the normal one of 870 volts p-p. The bottom trace shows the more jagged waveform resulting from an open C213. No other defect in the set will produce this kind of wrong waveform.



was the loss of regulation of the 24-volt supply.

From 75 volts to 130 volts RMS at the input power cable no change of picture could be noticed.

#### What if C213 is okay?

If C213 is not open, but the +130 supply measures +105, what components should be suspected? To answer that question, we need only to go back to DC-rectifier theory. An open CR201, CR202, or C214A would reduce the voltage that much. The tip-off would be the huge increase of ripple. If either rectifier were open, the ripple would be 60 Hz instead of 120 Hz, and the ripple amplitude would be about double. But if C214A were open, the ripple would be an excessive 120 Hz. Remember that the transformer regulates the AC to the rectifiers, **not** the DC. Excessive drain or an open component, such as diode or capacitor, can reduce the DC voltage.

#### Overloads

These four DC supplies are just as susceptible to overloads from circuit shorts as others are. Any major overload in any supply should flip the circuit breaker in the usual way.

#### Locating The Voltages

Anytime you suspect problems with any of the DC power sources, we recommend you measure the DC voltage. All test points can be reached merely by removing the back, and it's easy if you know where they are.

Here is a list of the supplies and their locations:

- **+23 volts.** Measure at terminal W15 of the 9-103 sound module;
- **+24 volts.** Measure at terminal W9 of 9-89 video-output module;
- **-36 volts.** Measure at terminal W3 of the 9-92 vertical module;
- **+36 volts.** Measure at terminal U2 of the 9-92 vertical module;
- **+130 volts.** Measure at the flyback terminal with the white wire;
- **+240 volts.** Measure at terminal U30 of the 9-89 video-output

module; and

- **+700 volts.** Measure at the high terminal of any screen control. Incidentally, the "W" and "U" numbers are difficult to locate on some modules. We will locate these for you as we discuss each module.

#### CRT Heater Problems

If there is no raster, but the sound is okay and you can hear the rustle of high voltage when the set is switched on, suspect the fuse in the CRT heater circuit (F202 in Figure 5). Usually you can see if the heaters are glowing or not.

Correct value of the fuse is 2 amperes for 17EC45 and 19EC45 chassis, and 4 amperes for 17FC45 and 19FC45 versions. Also, with the "EC" models, be sure not to turn the set on by plugging in the power cable during testing. The higher surge of a completely-cold heater is likely to blow the fuse, even when there's no defect.

The heaters of the picture tube are floated at about +130 volts to minimize the possibility of heater-to-cathode shorts. Because the heaters are bypassed by C221 (.1 capacitance), an H-to-K short would remove both video and color from the gun affected, giving very poor pictures. This is different from the older sets, in which an H-K short removed the video **only**, either from all three guns or just one, depending on the drive control settings.

#### High-Voltage Problems

If one or more of the IC's or small transistors short or open at the same time, measure the +24-volt supply first thing. A short in the regulator transistor, Q201 or an open CR204 (Figure 7) would zoom the voltage up to nearly +36 volts, and bring the possibility of wholesale destruction of solid-state components.

#### Next Month

Troubleshooting the horizontal oscillator and sweep circuits will be discussed in the next installment. □

# FAST RELIEF FROM SOLID STATE HEADACHES



Now with  
E-Z Hook leads!

There's nothing else like the Hickok Model 215 Pocket Semiconductor Tester.

- It's simple to use — no set up — no data books.
- It automatically determines lead configuration.
- LED displays indicate if semiconductor is GOOD or BAD and identifies base lead (gate for FET's) and whether NPN or PNP.
- Operates on 9V batteries.
- Weighs only 12-ounces and fits in your pocket.

We back the Model 215 with the best warranty in the business — two full years.

The Model 215 or our bench Model 220 are values you have to see to believe. Ask your Hickok distributor for a demonstration or contact us for more information.

**\$13800**

## HICKOK

the value innovator

INSTRUMENTATION & CONTROLS DIVISION  
THE HICKOK ELECTRICAL INSTRUMENT CO.  
10514 Dupont Avenue • Cleveland, Ohio 44108  
(216) 541-8060 • TWX: 810-421-8286

For More Details Circle (7) on Reply Card

# Your VTVM is obsolete!

This may sound like a harsh claim, but it's true. Thousands of TV technicians are using instruments designed in the 1950's to troubleshoot circuits designed in the 1970's.

And now, most color TV's have solid state circuits. So use of out-of-date test equipment just compounds the problem.

The generation gap has grown too big.



The Fluke 8000A 3 1/2 digit multimeter

## Solid state calls for new performance standards.

Your "old fashioned" test equipment simply doesn't measure up to today's requirements. For example, the typical VTVM gives you 5% accuracy and 2% resolution. In the old days, that was good enough. Not so today.

Now you need an instrument to look at the voltages at each pin of an IC with sufficient accuracy and resolution to determine proper IC operation.

For example, a reading of "around 2.8 volts" is no longer sufficient. You must be able to distinguish between 2.80 and 2.82 volts.

You need a test instrument that gives you 0.1 ohm resolution so you can reliably measure resistance of switch contacts, circuit breakers, and low value resistors.

To do all this and more, you need the superior capabilities of the Fluke 8000A 3 1/2 digit multimeter.

## An instrument designed specifically for testing solid state equipment.

The 8000A gives you up to 50 times the accuracy and 20 times the resolution of a VTVM, so you can measure the various voltage levels in a solid state chassis with absolute confidence.



Resolution is 100 microvolts, 100 nanoamps and 100 milliohms

You get the sensitivity you need for low level dc measurements. The 200 millivolt range with 100 microvolt resolution tells you *exactly* what your values are.

The 8000A has an AC frequency response from 45 Hz to 20 KHz and, with accessory probes, to 500 megahertz. Resistance measuring capability ranges from 100 milliohms to 20 megohms. It offers a 15°C to 35°C accuracy temperature span. And a 1-year accuracy time span, meaning it seldom needs calibration.

Unlike other DMM's the 8000A has fast response time—3 readings a second. And the bright, digital readout means that no interpolation is necessary.

## The 8000A measures high voltages, too.

Our 8000A is designed to answer *all* the needs of an electronic service technician.

One very important (and talked about!) safety requirement is that the picture tube anode voltage must not exceed the maximum specified by the manufacturer. Our 8000A has an optional high voltage probe that gives you guaranteed accuracy of 1% at 25,000 volts. The probe also extends the capability of the 8000A to 40,000 volts to measure the high voltage in the new 32,000 volt chassis.

No other DMM's offer this feature.



High voltage probe accessory gives you 1% accuracy at 25,000 volts

## Get the most up-to-date instrument available.

Don't be caught in the typical trap. Many electronic service shops don't really update their equipment when they decide to update. Switching to a TVM or a FET voltmeter doesn't really give you the accuracy and resolution you need today, or for that matter, tomorrow.

But with the 8000A on hand, you know you have a *true* solid state testing device . . . an instrument that can do the job the way it should be done.



Carry it anywhere. Use it on line or rechargeable battery power. Note the conveniently mounted specs on the bottom decal. They're always with you.

The 8000A comes from Fluke, one of the largest instrument companies in the U.S.

It costs just \$299 (\$40 more with HV probe).\* And it is far and away the largest selling, most rugged and reliable 3 1/2 digit multimeter in the world.

\*Domestic only.

For data out today, dial our toll-free hotline, 800-426-0361  
John Fluke Mfg. Co., Inc., P.O. Box 7428, Seattle, WA 98133



For Demonstration Only Circle (8) on Reply Card  
For More Details Circle (9) on Reply Card

ELECTRONIC SERVICING



Chuck Levdar is shown in the Memorex tape laboratory troubleshooting a cassette problem.

# Is the cassette or machine at fault?

By Chuck Levdar, Quality Control Manager, Memorex Corporation

Much has been written in recent years about the technological improvements in both audio tape cassettes and cassette machines. But usually the discussions consider either one or the other, ignoring the interface between cassette and machine, which is equally important to the successful operation of the system. Because of this oversight, many problems are attributed to the cassette, when the cause actually is a misalignment of the record/play head guide, erase head guide, capstan or pinch roller.

If these components are not correctly aligned, they might ruin a cassette in one play. This is in addition to causing inferior audio quality. And there is no assurance of correct performance merely because a particular machine is new.

We at the Memorex tape-cassette factory have studied these problems for some time. In recent years, we have tested numerous cassette machines of many brands in our product test laboratory (Figure 1). All machines were purchased through normal retail outlets.

In these tests, we found that approximately 50% of the machines were improperly aligned. As you might imagine, the percentage varies somewhat between the expensive

decks and the small portables. However, about 25% of the expensive machines needed re-alignment. These facts help to explain the many difficulties users have had with cassette machines, especially with the longer-length tapes.

## Diagnosing Alignment Problems

The first (and most important) step in diagnosing mechanical cassette problems is to test the machine with a **good-quality** cassette. Watch out for bargain-basement poorly-constructed cassettes, for they can produce symptoms similar to those caused by machine misalignment. This can make proper diagnosis difficult or impossible. The alignment of tape path and guidance components of cassettes is just as important as the accuracy of tape path in the machine.

### Tape-edge damage

Damage to the edge of the tape (Figure 2) is a prime indication of an alignment problem in the machine. Audibly, the edge damage might first appear as a variation of volume in one channel (usually the track at that edge). Extreme cases of edge damage are easy to spot visually.

If the edge damage is severe

enough, it can result in a seized or jammed cassette. Quite often, the tape spills out of the cassette and becomes wound around the capstan or pinch roller. The 90- and 120-minute lengths are more susceptible to this type of tape failure, because the tape is thinner than that used in the shorter-length cassettes.

Wrong centering of tape in the head is the most likely cause of edge damage. Although, certain kinds of capstan/pinch-roller misalignment either produce edge damage or a crease in the center of the tape.

### Proper Head-Guide Alignment

It's essential for the tape to be centered exactly in the cassette, and for the head height to be correct so the tape will pass through the middle of the tape guides on the head (Figure 3). A wrong height of the head forces the tape to crowd the tape guide (Figure 4), and stretch or bend the edge of the tape.

The permissible deviation from correct guide position depends somewhat on the design of the machine. For example, dual-capstan types require a more-accurate alignment. But in general, about .005 inch is the maximum error that can be tolerated.

The easiest and most-accurate way of checking alignment of the head guides is to use a mechanical alignment fixture (jig). Such a fixture (Figure 5) can be obtained for about \$85 from: Information Terminals Corporation, Sunnyvale, California. The fixture is a metal plate of accurate dimensions that is positioned in the machine in place of a cassette. Top surface of the plate should line up with the lower guide. There is a metal gauge finger which serves two purposes. First, it checks head-guide alignment. If the guide is not aligned correctly, the gauge will not slide between the head guides. Secondly, it checks head

penetration. The lines scribed on the plate mark the limits of insufficient and excessive head penetration.

#### Azimuth alignment

If the head guides are incorrectly positioned, they must be adjusted by moving the head up or down. However, it is imperative that the azimuth (perpendicularity of head gap to the tape edge) be correctly maintained during the alignment adjustments.

An alignment (test) tape must be used to check the azimuth. These tapes are recorded with a series of frequencies, the highest one permit-

ting the most accurate adjustments. It is essential for best results that you make the head-height and azimuth (tilt) adjustments alternately several times. The process is not difficult, but it does require the proper equipment, plus much care and patience.

#### Capstan/Pinch-Roller Alignment

Ideally, the axes of both the capstan and the pinch roller should be perpendicular to the plane of the cassette (and perfectly parallel with each other). Any deviations will result in the tape being driven up or down by the action of the capstan



Fig. 1 Random samples of cassettes from current Memorex production are tested for performance and durability on many brands of machines.

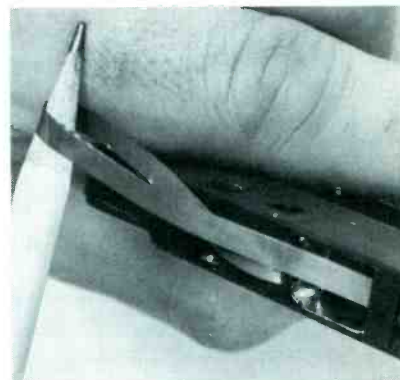
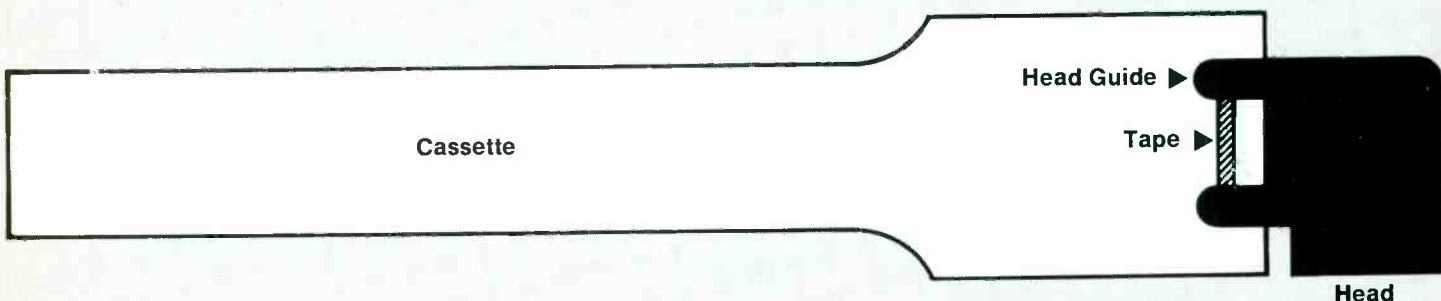
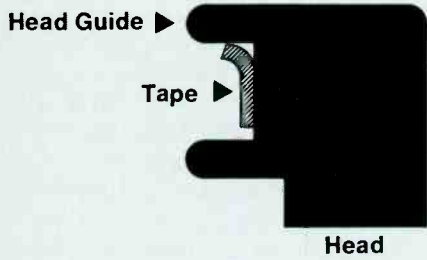


Fig. 2 A ragged or creased edge can cause poor audio quality on one of the tracks. Severe damage can cause the cassette to jam, and the tape to wind around the capstan or pinch roller.

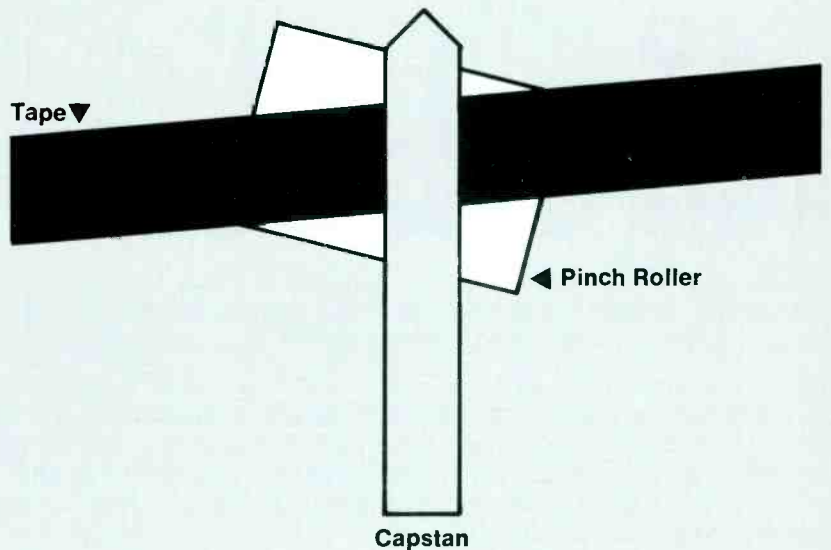
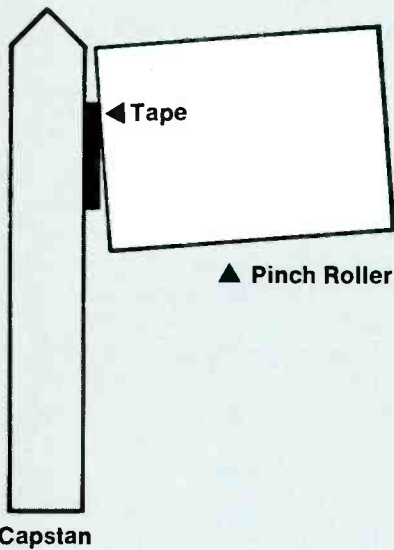
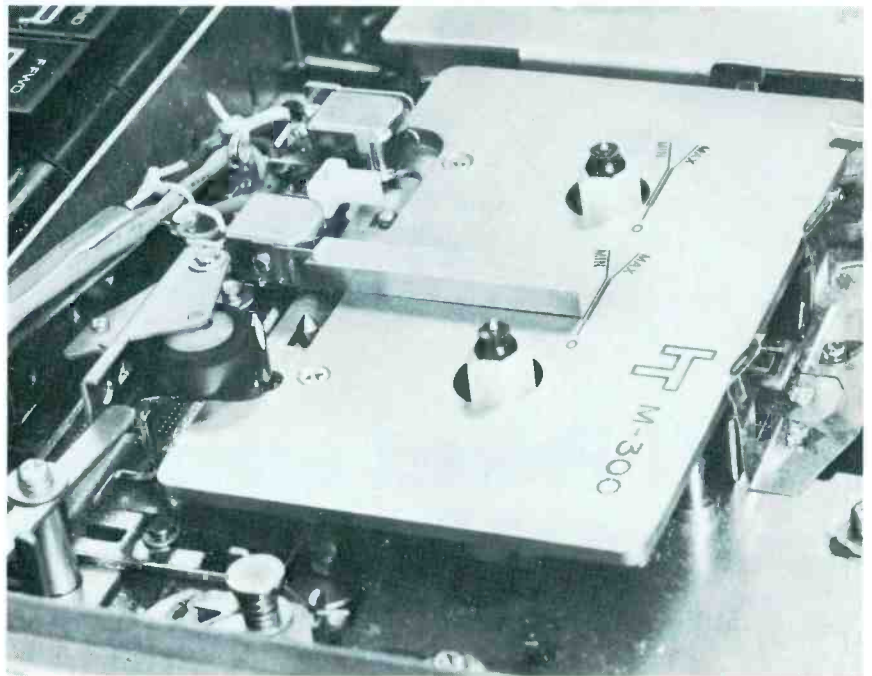
Fig. 3 An accurately-aligned head guide will position the tape exactly in the center of the cassette.



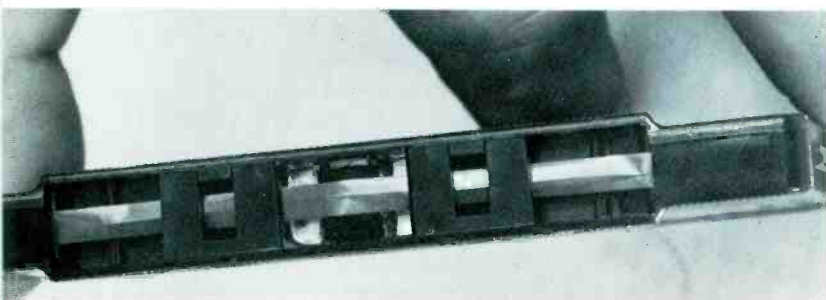


**Fig. 4** If the tape is in a strain because the guide is too high or too low, it will be bent or stretched out of shape at the edge.

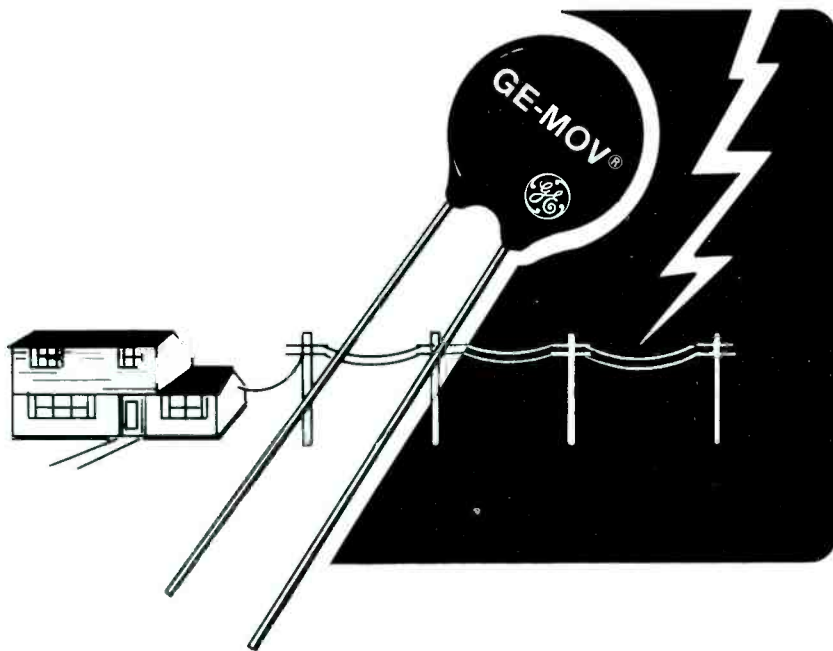
**Fig. 5** An alignment fixture is necessary for rapid and precise testing and adjusting of head-guide alignment. This one is Model M-300 sold by Information Terminals Corporation of Sunnyvale, California for about \$85. The metal finger (simulating the tape) should slide easily through the head guide to the head. Then, markings on the plate show the amount of tip penetration.



**Fig. 6** These are two of the possible misalignments of capstan and pinch roller that can cause bending or creasing at the center of the tape.



**Fig. 7** This is how the tape looks after it has been creased in the center because of wrong capstan/pinch-roller alignment.



# NOW! Protect against Transient Voltage Damage to TV, Stereo and Home Appliances with **GE-MOV<sup>®</sup>** Metal Oxide Varistors.

TV Set manufacturers know that many component failures are caused by voltage transients: lightning, voltage spikes and power surges. Now you can do something about it . . . economically.

Insert easy to install GE-MOV metal oxide varistors in component circuits and prevent damage from transient voltage once and for all. The varistor absorbs the dangerous transient and dissipates it as heat. The cost is low. The installation fast and easy. It's like offering your customers an insurance package . . . and it's an opportunity to make a profit!

Our GE-MOV program is ready and waiting. For all the facts about this addition to General Electric's growing replacement semiconductor line, see your authorized distributor.



TUBE PRODUCTS DEPARTMENT  
GENERAL ELECTRIC COMPANY  
OWENSBORO, KENTUCKY 42301

**GENERAL**  **ELECTRIC**

and pinch roller (Figure 6). Typical damage of the tape from such misalignment is a crease along the center (Figure 7).

Diagnosis of this type of misalignment is very difficult, because the problem often is erratic and inconsistent. It depends on many variables such as tape thickness, pack size, and take-up tension of the machine. Perhaps the best way of diagnosing is to watch the tape pass between the capstan and the pinch roller. The tape should move in an even line and not oscillate up and down, or track with part of the tape above or below the pinch roller.

Make your own tool for this visual analysis by removing enough of the plastic above the tape path of a test cassette so you can observe movement of the tape.

Improper tracking often is most pronounced just after starting to play a cassette in the middle of the tape. Of course, with some machine designs, it's not possible to observe the tape passing between the capstan and pinch roller. In that case, repeatedly start and stop the machine in the middle of the pack of tape. Then, remove the cassette and rewind the tape (using a pencil placed through the hub) while you watch for damaged sections, such as those shown in Figure 7. It's best to use a 120-minute cassette because the thin base is more susceptible to damage.

Correcting misalignment of capstan and pinch roller can be a major job. A worn or bent pinch roller can be fixed by replacement of the parts. Often, they come in an assembly.

Misalignment caused by a worn capstan bearing or a bent capstan shaft is a more-serious problem.

## Summary

Diagnosis of cassette alignment problems often is made easier by information you can obtain from the customer about the symptoms, plus visual evaluation of a cassette that has been used with (and damaged by) the machine.

Interface between tape and machine only can be correct if a premium-quality cassette is operated in a machine having correct mechanical alignment. The only specialized tools needed to improve alignment are an alignment gauge and an azimuth-alignment tape. □

# Reports from the test lab

By Carl Babcoke

*These monthly reports about electronic test equipment are based on actual examination and operation in the ELECTRONIC SERVICING laboratory. Observations about the performance, and details of new and useful features are spotlighted, along with tips about how to use the instruments for best results.*

Hewlett-Packard Company manufactures electronic test equipment of extremely-high quality for use in research, broadcasting, and other fields requiring precision devices. Only recently has H-P directed some of its extensive know-how into building scopes, frequency counters, and digital meters whose specs and prices fit the needs of the service industry. Remember the tiny auto-

ranging and auto-polarity digital VOM shown on the front cover of *Electronic Servicing* for January, 1974?

One of my favorite items of test equipment is a triggered dual-trace scope. So, I eagerly looked forward to testing the new H-P scope.

## Hewlett-Packard Scope

These are a few features of the Model 1220A solid-state, dual-trace triggered-sweep scope by the Hewlett-Packard Company:

- The 5" CRT has 8X10 centimeter markings, with the graticule lines on the **inside** of the faceplate to prevent parallax (errors because of the viewing angle);
- Power drain is only 40 watts, permitting cool operation without a fan;

- Both high-gain vertical-amplifier channels have maximum sensitivity of 2 millivolts-per-centimeter, and response up to 15 MHz with rise time of 23 nanoseconds;

- The horizontal sweep has 21 ranges of scan time, more than sufficient for TV servicing. For example, the slowest scan takes 5 seconds to cross the entire screen, and the .1 microsecond range shows a total of only 4 cycles of 3.58 MHz sine waves (even without the X10 widening control);

- An internal sync separator makes locking of TV signals easy, especially video waveforms scanned to show two vertical fields;

- The "Beam Finder" button reduces the scan in all four directions to locate any waveforms that might be off the screen;

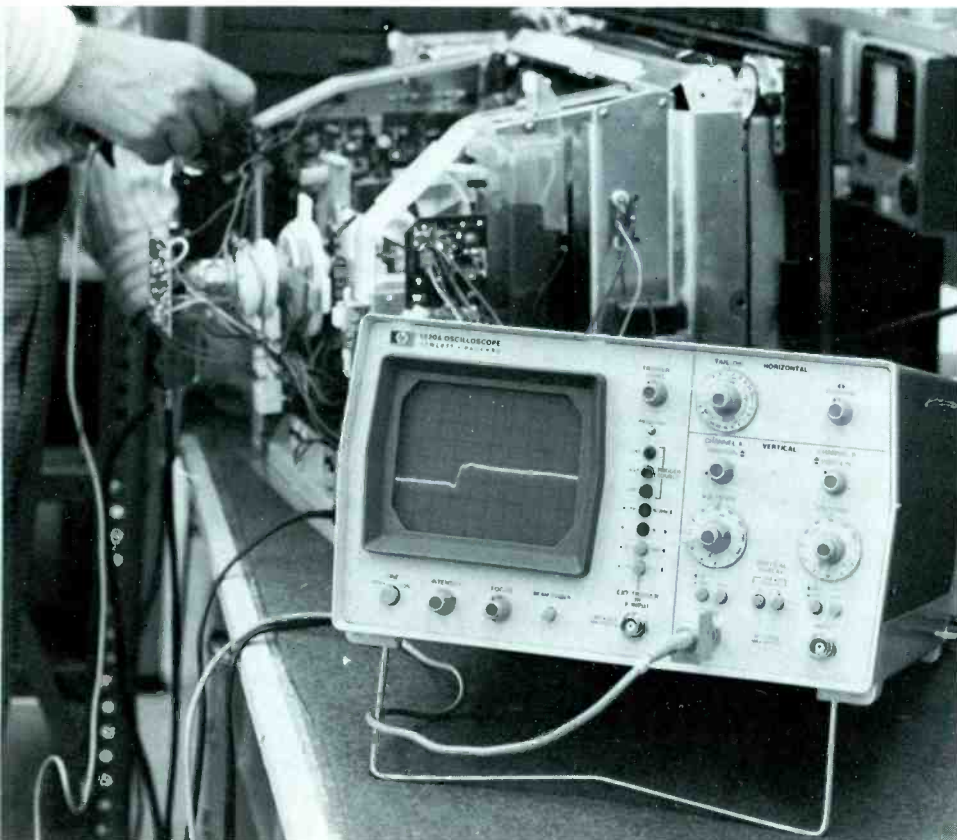
- Only one control is necessary for horizontal locking. Even without a signal in the vertical channels, there is a horizontal line; and

- The scope operates in three different modes: with one waveform in the usual way; with two time-shared traces; and as an X-Y display for phase.

## Vertical Amplifiers

The two vertical amplifiers are identical as required for dual-trace and X-Y operation. Input impedance of each is 1M shunted by about 30pF. Of course, that's too much load for many TV circuits, and I recommend that an X10 probe be used. Maximum gain is 2 millivolts, and operation with an X10 probe at all times would lower the gain only to 20 millivolts; that's more than enough gain for all TV servicing, with the possible exception of tracing the IF's with a demodulator probe.

Twelve ranges of sensitivity are provided by the VOLTS/DIVISION switch in a 1-2-5 progression, with the least-sensitive range deflecting 10-volts-per-centimeter. Multiply the X10 loss of the probe times the 8 centimeter vertical markings for a maximum of 800 volts p-p. But



The color-keyed and uncluttered front panel of the Hewlett-Packard Model 1220A dual-trace triggered-sweep scope indicates logical and simplified operation.

that's just the limit with the concentric vernier gain control at the calibrate (maximum gain) position. By turning down the vernier, the screen can show complete waveforms having voltages higher than those that are safe for the probe and the input circuitry.

Two latching-type pushbuttons for each channel select the kind of input condition. One provides DC operation (direct coupling from probe to CRT) or AC (input through a blocking capacitor). The second disconnects the input from the vertical amplifier, and is useful for those times you want to find the true zero-voltage line. Only triggered scopes seem to have this feature. It's one I use often.

#### Frequency response

Our lab equipment is not adequate to test instruments of such wide and accurate frequency response. Therefore, we use square waves.

Square-wave tilt at 20 Hz was less than found in some scopes (see Figure 1), and was not noticeable at 60 Hz. That's good performance.

Figure 2 shows both sine and square waves at 200 KHz. The scope response far exceeds that of the generator.

BNC-type connectors are provided for both inputs, and for the EXT TRIGGER/X INPUT. Each channel has a vertical-centering control.

#### Dual-trace operation

Dual-trace operation is not a function of the CRT (some have dual beams), but is produced by one of two methods of time sharing.

By the "alternate" method, the waveform present in one vertical amplifier is displayed for one complete horizontal sweep. Then during the next sweep, the waveform of the other amplifier is shown, etc.

Alternate displays would produce too much flicker at slower trace speeds, so to avoid that problem the two waveforms are alternated in tiny bits at the rate of 200 kHz. This is called "chop" mode.

Regardless of the method, persis-

tence of both the CRT phosphors and the eyes of the viewer act to simulate the appearance of two complete and separate waveforms. Of course, the brightness is less than with just one waveform.

In this scope, chop mode is selected automatically for horizontal sweeps between .5 S/CM and 1 millisecond/CM, while alternate channels are displayed on sweeps from .5 millisecond/CM to .1 microsecond/CM.

#### Vertical Display

Two buttons, one A and one B, select the channels to be displayed. For example, either channel A or channel B signal can be displayed as a single trace with internal sweep locking taken from the one in use. Or both buttons can be depressed for dual-trace operation. In that case, the locking for the horizontal sweep is taken from channel A. This is a flexible and useful method.

#### Horizontal Sweep

The TIME/DIV (time/division) switch has 21 ranges from .5 S/CM (which takes 5 seconds for the beam to traverse the width of the screen) to .1 microsecond-per-centimeter, which displays 4 cycles of a 3.58 MHz carrier (Figure 3).

In addition, there is a concentric-mounted EXPANDER variable control that continuously can widen the picture up to a maximum of 10 times. By using the EXPANDER control and the horizontal POSITION control, you can stretch a part of a waveform (Figure 4). Most triggered scopes have a switch to widen the sweep by 5X, but without any variable adjustment. Others have a vernier time/division control that permits selection of timed sweeps between the switch positions.

Although the EXPANDER does not change the sweep time, it has the effect of making the sweep go ten times faster. The trade-off is that the brightness and sharpness suffer.

Only a TRIGGER LEVEL variable control is required for locking at any selected part of the

waveform. One different feature is that without a signal in the vertical amplifiers, the sweep automatically operates to produce a horizontal line. Most triggered-sweep scopes don't show a line without a signal in the triggering channel to initiate the sweep.

#### Internal sync separator

Triggering sources for the horizontal sweep can be taken from the vertical amplifiers (INT button), from a signal at the EXT TRIGGER jack (EXT pushbutton), or from an internal connection to the 60-Hz power source (LINE button).

In addition, the TV/NORM button switches in an internal sync separator when the TV function is selected. This is very helpful when you view composite video at the "vertical" rate.

Other buttons select: positive or negative sync signals, as required for tightest locking; an X-Y position for vector or phase displays; and the X signal either direct or attenuated 10 times.

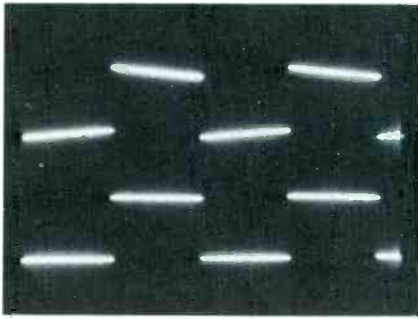
#### CRT Controls

Underneath the scope screen are the on/off switch, the INTENSITY variable control, FOCUS control, and the BEAM FINDER button. Of course, the INTENSITY and FOCUS controls adjust the brightness and sharpness of the trace, and they operate the same as those on other scopes.

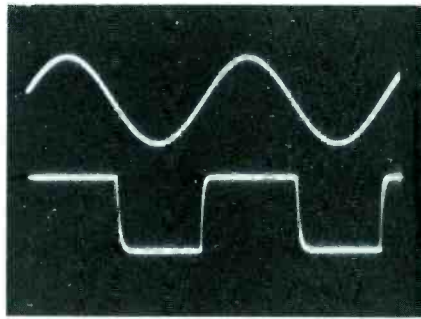
The BEAM FINDER is something unique for service-type instruments. Suppose you were using the DC function of the vertical amplifiers, attempting to see a small amplitude AC signal superimposed on a large DC voltage. The images might be completely off the screen, and appear to be a loss of brightness. In that case, you press the non-locking BEAM FINDER button and the waveforms are brought back to the center of the CRT screen, as shown in Figure 5. Movement of the waveforms is rapid, but you can see it well enough to guide you in making gain and centering adjustments so the waveforms become visible.

The second picture shows that

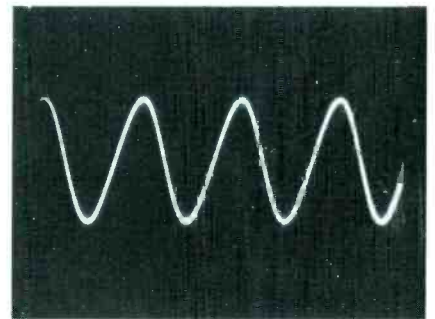




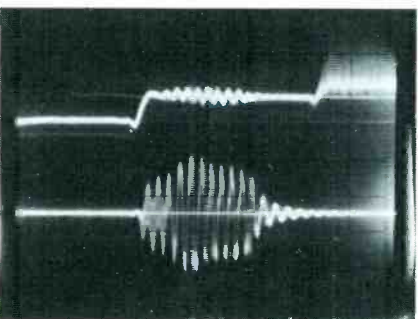
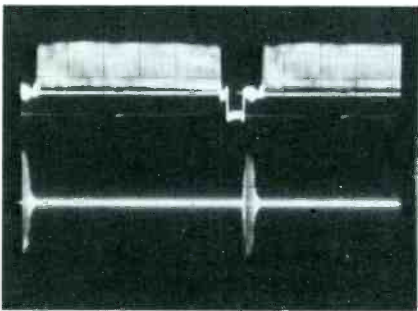
**Fig. 1** Top waveform shows the small amount of tilt produced by AC operation of the vertical amplifier with 20 Hz square waves. The bottom trace was made under the same conditions, except the coupling was DC.



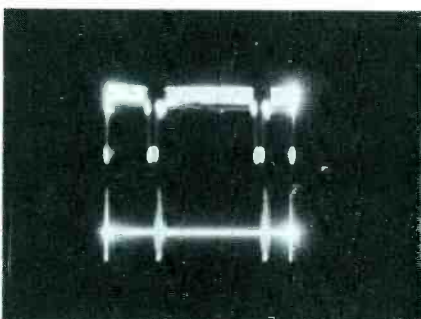
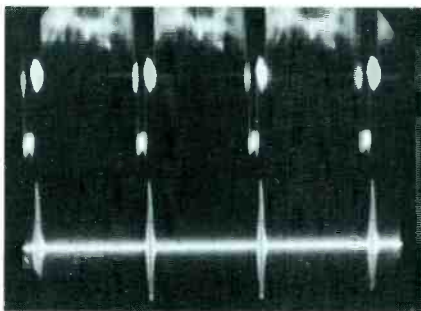
**Fig. 2** These waveforms only prove that the bandwidth of the scope far exceeds that of the generator.



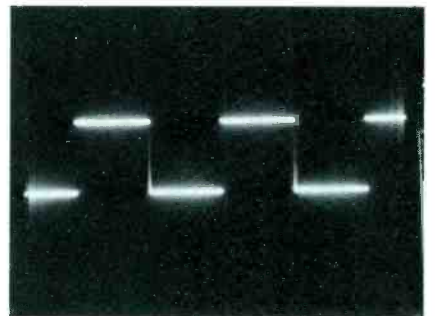
**Fig. 3** It's unusual for a scope to have sweep times as short as .1 microsecond, which shows only four cycles of a 3.58 MHz color oscillator signal. And, that is without using the X10 width control called EXPANDER. Notice the horizontal linearity is good, even at this extremely-fast sweep.



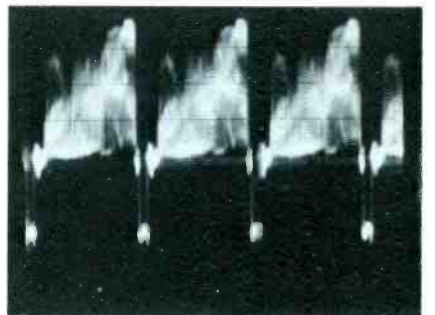
**Fig. 4** The horizontal width variable EXPANDER can be used to spread out any portion of a waveform. For example, the dual-trace waveforms of the picture at the top showing video and color burst signals can be widened (bottom picture) enough to permit counting each cycle of the burst. It's likely the parts of the waveform not shown are compressed. But that's not important, for the sections you can see are very linear.



**Fig. 5** Both waveforms of the top picture are partially off the screen. When the BEAM FINDER button is pressed, both vertical and horizontal sweeps are compressed at all edges of the screen, bringing a distorted pattern to the center (picture at bottom). So, even if the traces are completely off the screen (giving the symptoms of no brightness or a loss of sweep) operation of the button will show what adjustments of centering or gain are necessary to bring the waveforms into view.

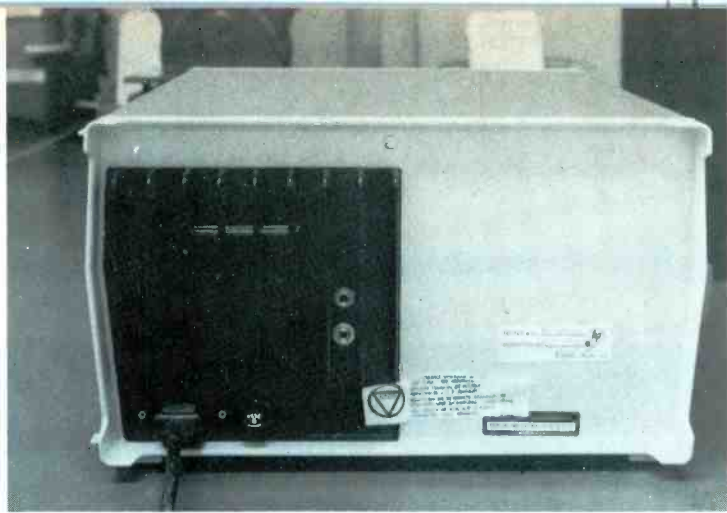


**Fig. 6** This is the .5 volt p-p 2-KHz square-wave signal at the "touch" terminal labeled PROBE ADJ. With the low-capacitance probe contacting the terminal, the adjustment in the probe is turned for sharpest corners without overshoot.



**Fig. 7** The black graticule markings are inside the CRT to eliminate parallax. They show in room light, or across the waveforms.

Fig. 8 A large heat sink for the power transformer occupies much of the rear panel. Slide switches are provided for line voltage selection, and jacks are there for "Z" axis modulation, and a source of voltage for the H-P scope camera.



the waveforms are changed very little near the center of the screen, but are compressed at the edges so the display can't be more than about 2-inches square.

#### Probe Adjustment

Each Hewlett-Packard low-capacitance probe has an adjustment for matching the probe to the individual scope to obtain best high-frequency response. Just below the TRIGGER LEVEL control is a "touch point" marked PROBE ADJ that is supplied with a 2-KHz square-wave signal of .5 volt p-p (Figure 6).

Touch the probe to the test point and (while looking at the waveform on the screen) adjust the probe capacitor for sharpest corners of the square waves without overshoot.

#### CRT Characteristics

The 5-inch CRT has mono-acceleration, with 2KV of accelerating voltage, and a screen of P31 phosphor. The only reservation I

have about this scope is that the trace has only average brightness and sharpness.

Black graticule lines are on the inside of the CRT faceplate. They can be seen by roomlight, or silhouetted in front of the waveforms (Figure 7). Therefore, no light for the graticule is needed. A blue filter is placed in front of the screen to improve contrast when outside lighting is excessive.

#### Physical Features

A large heat sink connected to the power transformer occupies much of the cabinet back (Figure 8). Jacks for X modulation and power for H-P scope cameras are mounted on the heat sink, along with sliding switches to select the desired line voltage.

Plastic feet on three sides allow the scope to rest on the bottom, right side, or the back.

The carrying strap is on the left side, and underneath is the wire support used to tilt up the front of

the scope for better visibility of the screen.

When you take off the top cover of the scope and look inside, you can see some reasons why Hewlett-Packard has a reputation for quality design. Figure 9 gives some idea of the extreme attention to detail, shown by the layout of boards and components. In addition, the plastic cabinet is moulded to furnish support for all major assemblies.

Although it's not likely that many of these scopes will need servicing during the warranty period, it is reassuring to know that H-P products are distributed worldwide, and the company has more than 53 sales and service offices in the United States.

#### Single Trace Scope

The Hewlett-Packard Model 1221A is identical to the one just described, except there is only one vertical channel; it is not dual-trace. □

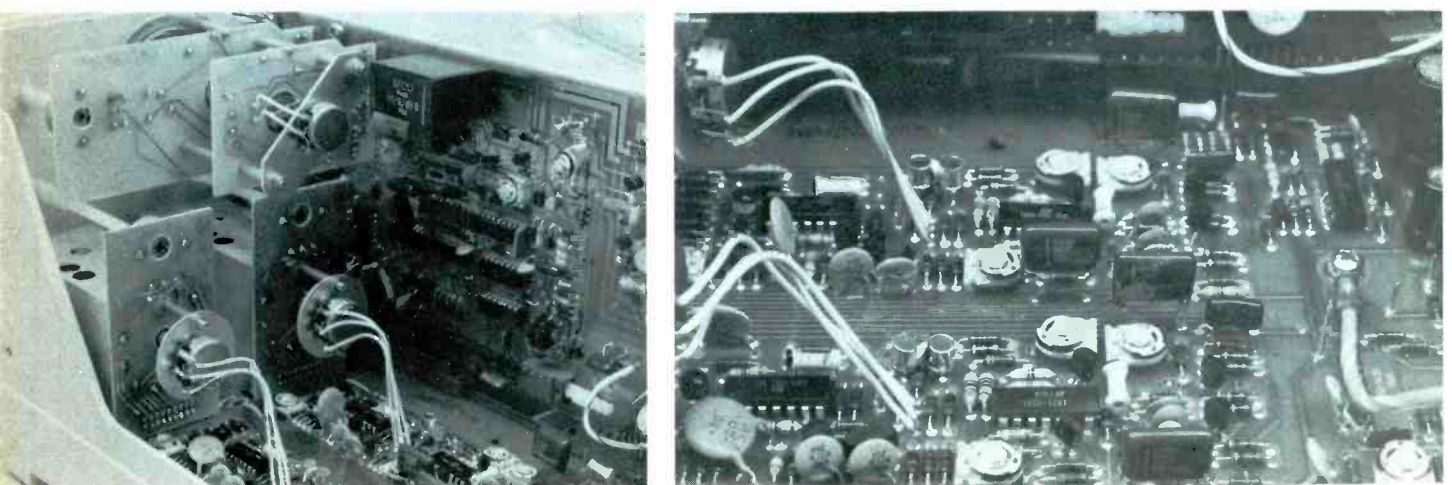


Fig. 9 These pictures show some of the solid and attractive wiring inside the Model 1220A H-P scope.

# One billion tubes can fail right now!



There are over 100 million tube type TV sets with sockets filled by tubes that may eventually fail. That's hundreds of millions of opportunities for a full mark up service profit. And it's an opportunity that's growing every year with millions of tube and hybrid TV's projected for manufacture and sale in the 1970's.

The profit is in finding the defective tube quickly, regardless of the kind of fault. Every B&K Tube Tester is specifically designed to permit an almost instant test when the tube is inserted into the socket. Unless you want to

use them, extra adjustments and switches seldom need to be used. Models with more controls are ready for any new tube type that may come along and the B&K tube chart service keeps you always up to date.

Every B&K Tube Tester gives you the most tester for its size. You know you're carrying the best and that the resilient round cornered case won't scratch your customer's furniture. Check the specifications to choose the tube tester that matches your needs. See your B&K distributor for more details or write Dynascan.

## Dynamic Mutual Conductance Testers

**747B**—21 socket Jet-Check section with only 2 settings. Programmed section for obsolescence protection. 1 megohm and 0.5 microamp sensitivity for shorts and leakage! Life test to reduce call backs. Separate multisection tests. Safe, accurate voltage regulator tests!

**\$271.00**

## Emission Testers—Now with new resilient cases!

**667**—Exclusive lockout pushbuttons open any tube's multiple connected pins for shorts test. Accurate simulated load test. High sensitivity grid emission and gas test. Only 3 or 4 settings. Superior load and plate voltage capability extend your obsolescence protection.

**\$150.00**

# **B&K** PRECISION

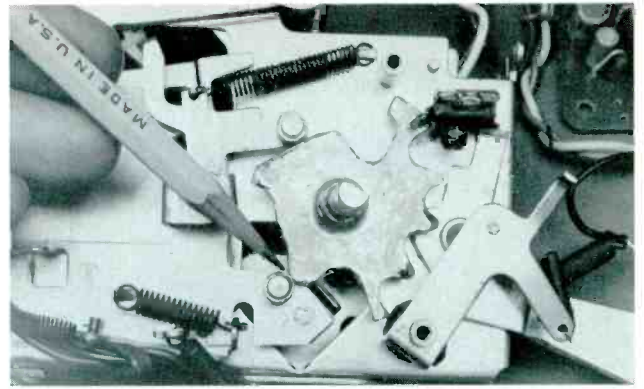
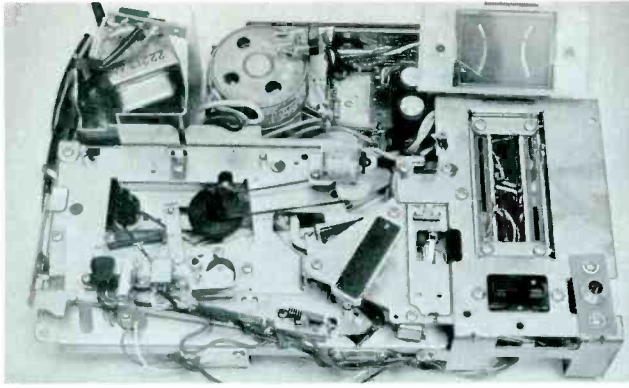
**PRODUCTS OF DYNASCAN**

1801 W. Belle Plaine Avenue  
Chicago, IL 60613

**666**—13 sockets and three controls. The latest version of B&K's old reliable that's proven in 20,000 service shops! Current loads simulate actual operating conditions. Checks each section of multi-section tubes.

**\$127.00**

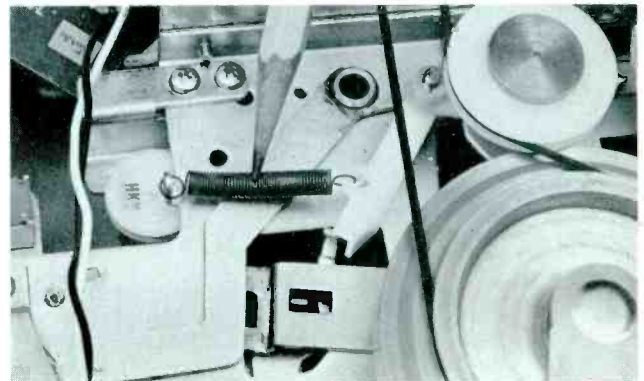
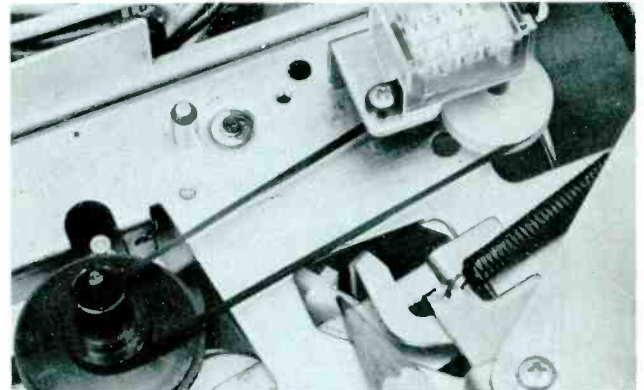
For More Details Circle (10) on Reply Card



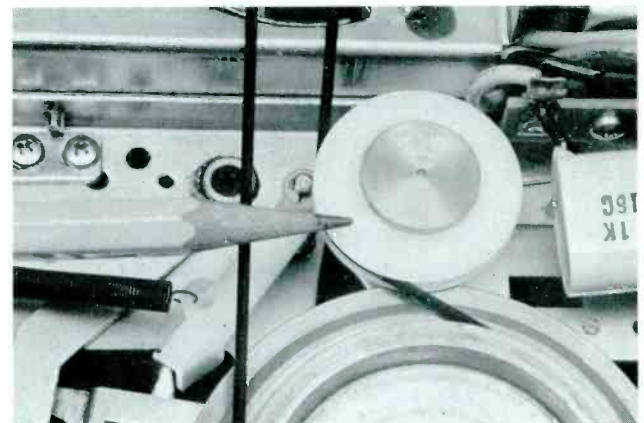
# Workshop on cassette recorders

Part 4/By Dewey C. Couch, Forest H. Belt Associates

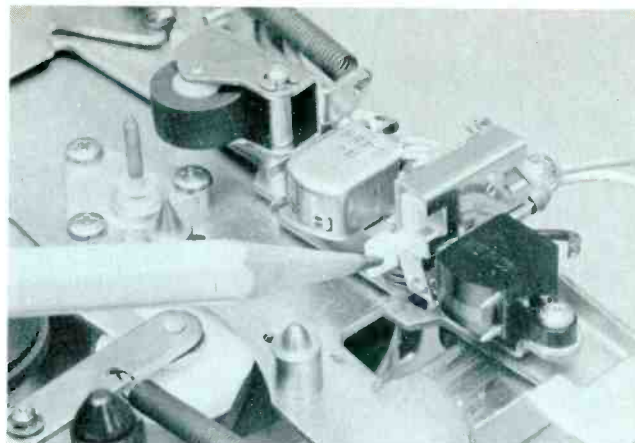
*In the first two sessions of this Workshop, we presented the basics of a logical approach to cassette servicing: cleaning, testing, adjusting, and making preliminary diagnosis. The third session showed how to analyze operations and assemblies of a pushbutton machine. This fourth and final session takes you through the other two basic cassette machines, the cam-switched and slot-loading models. The slot-loading types have become popular of late.*



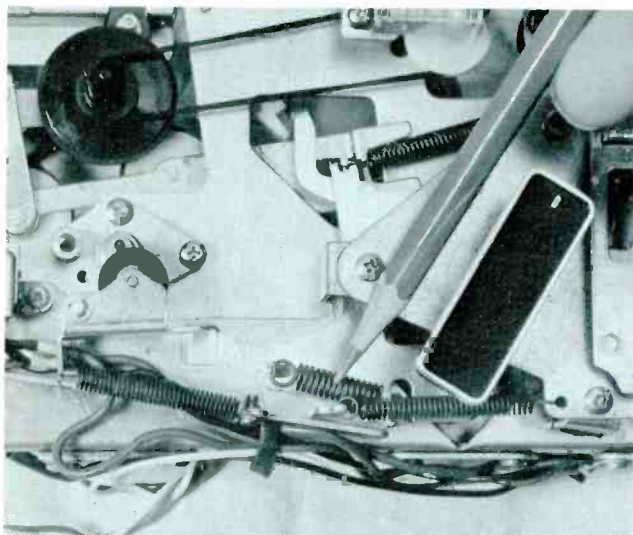
**Step 1.** A cam-switched machine has the same tape movement functions of Play, Fast Forward, and Rewind as pushbutton versions do. Only the method of selecting them is different. A serrated cam does all the mechanical switching, and a detent-roller assembly rides in the serrations to hold the cam in whichever position you select. Test by rotating the function knob to each position, and see if it latches firmly. If it feels loose or sloppy, replace the weak or loose detent spring. Also, the detent-roller arm can bind, making the switch either loose or hard to turn. Lightly lubricate the roller and cam using silicone grease.



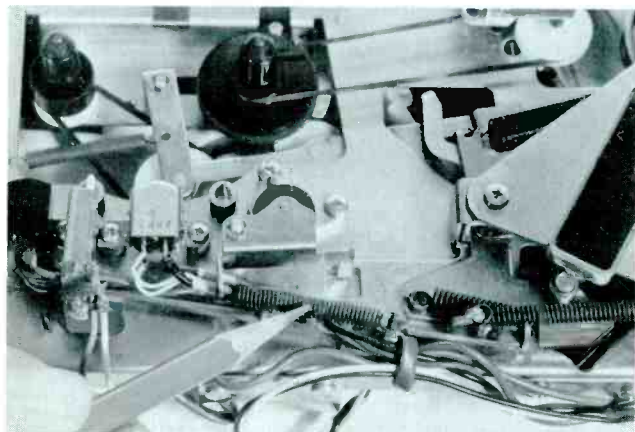
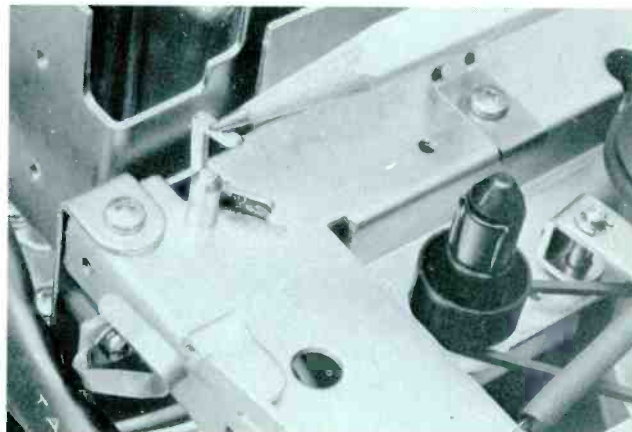
**Step 2.** When you turn the function knob to Play, the cam rotates and pivots the Play lever. A roller on the lever reduces friction and wear. A finger on the lever releases a plastic arm below the baseplate. The arm, pivoted by a spring, presses the takeup-drive pulley against the forward spindle. A belt-driven clutch arrangement turns the takeup pulley. If tape windup seems sporadic, try a new spring on the plastic arm. The felt clutch might be frayed or dirty, too.



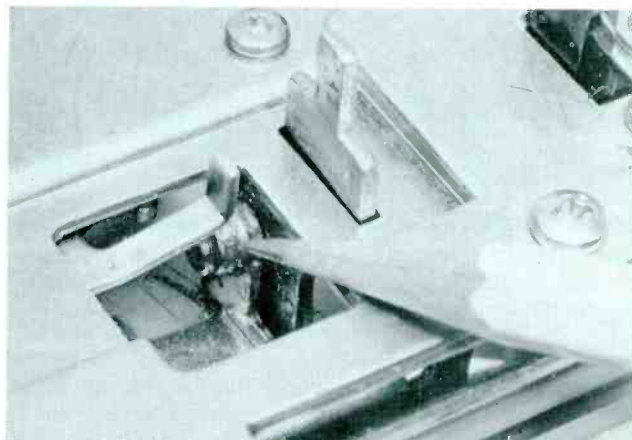
**Step 5.** A slightly-different automatic-shutoff system mounts on this head plate. The shutoff actuator is part of a switch. It presses against the moving tape, which has some slack. At the end of the cassette, tape tension increases and pushes the actuator back, closing the switch. That de-energizes a relay, cutting off AC power to the motor. However, in this automatic shutoff setup, all playback assemblies stay put until you move the function knob.



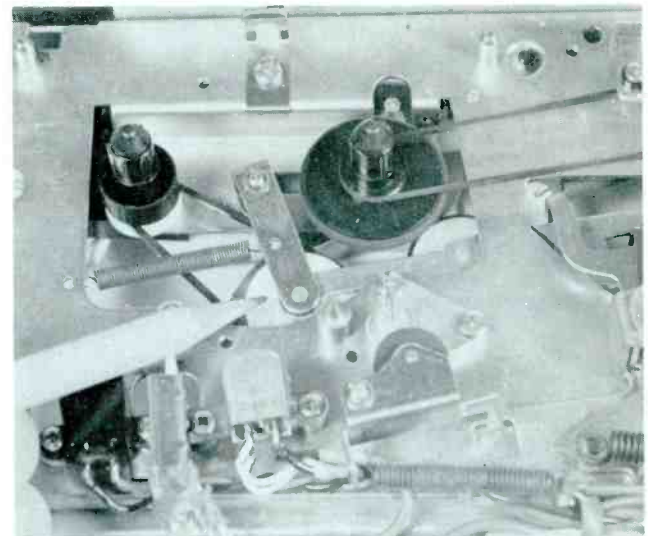
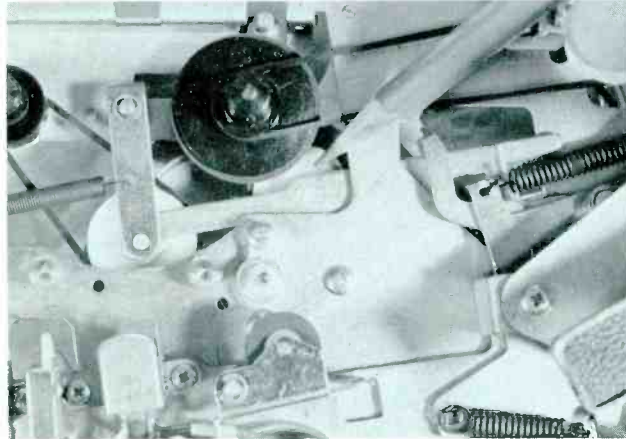
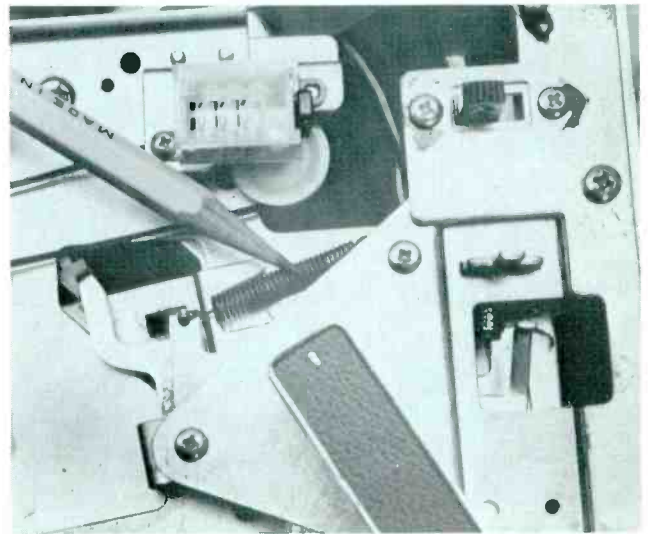
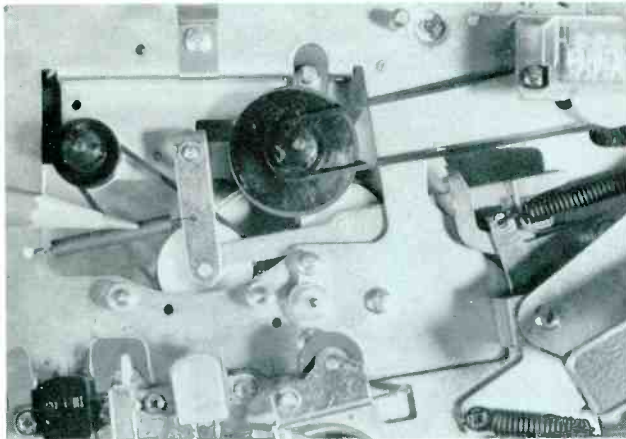
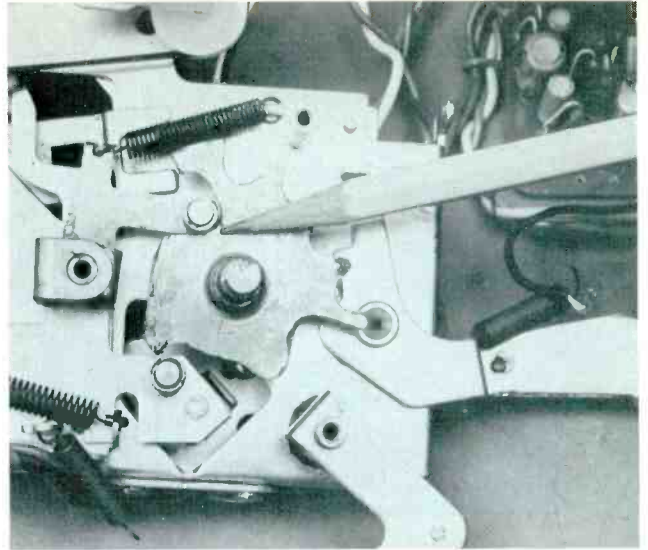
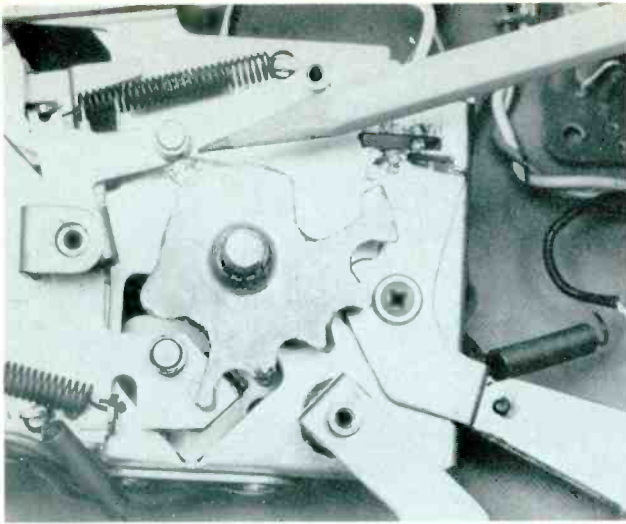
**Step 3.** The Play lever also moves a spring that pulls the head plate in, so the heads are against the tape. If the head plates moves sluggishly, its guide may be binding. A bit of lubricant should free it, if it's not bent. A bad tension spring won't pull the head plate far enough. A new spring should cure that.



**Step 4.** The pinch roller also mounts on the head plate in this kind of machine. Rotating the function knob to Play presses it against the capstan. Symptoms of too much or too little pinch-roller pressure were explained in Session 3, Step 7. The cure, on this particular machine, is a new tension spring (you can't adjust pinch-roller pressure).

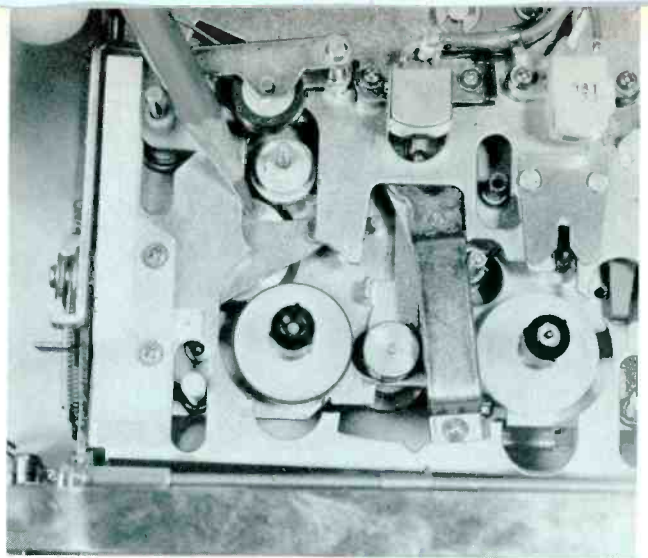


**Step 6.** The anti-record lever has to be pivoted (by insertion of a blank cassette, with tabs intact) before you can push down the Record button. Otherwise, the anti-record lever blocks the Record arm. When you hold down the Record button, a roller on the button shaft pivots the arm to change the position of the record/playback switch. If the Record button won't push down, first check the anti-record lever; the tab might be broken off, or the lever might be bent. Then inspect the Record button lever and roller. Finally, lubricate them properly.

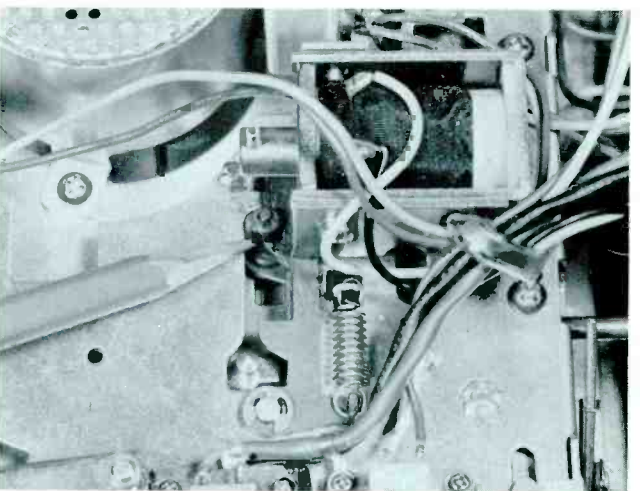
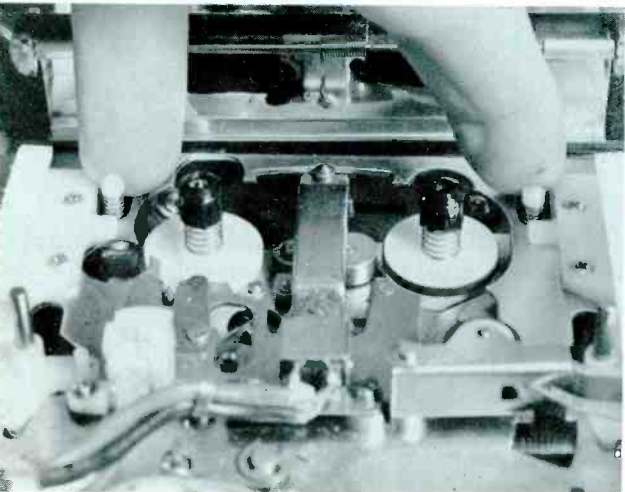
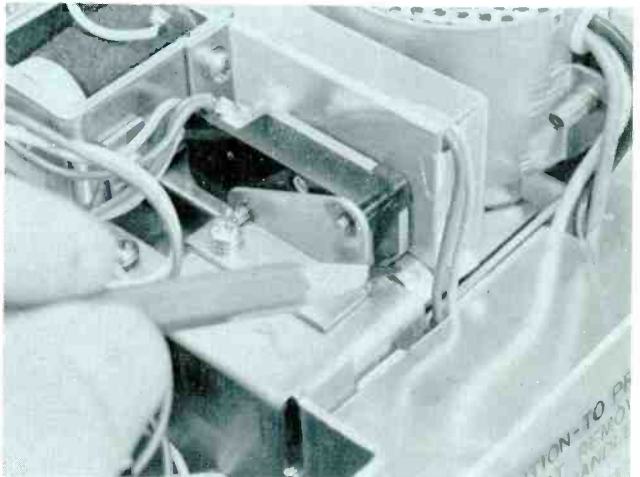
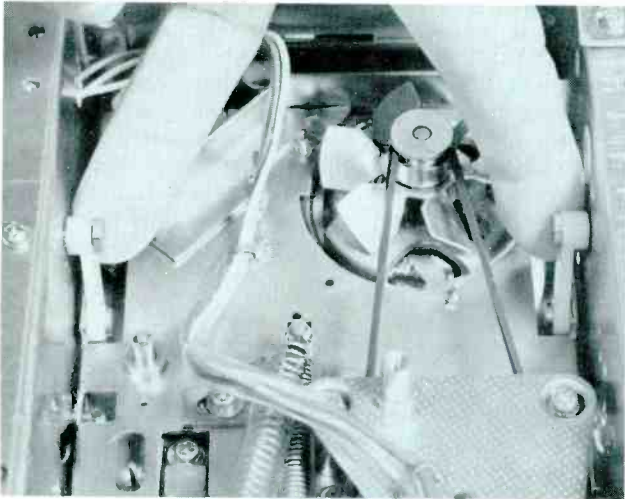


**Step 7.** To get this machine into Fast Forward, you have to rotate the function knob through the playback position. Turning the knob from Play to Fast Forward operates two levers. (1) The roller on the Play lever drops into a deep recess in the switching cam. A spring pivots the lever, pulling the takeup pulley away from the spindle. The Play lever also moves the heads back from the tape, and pulls the pinch roller away from the capstan. (2) The second lever, pivoted by pressure from the switching cam, releases the fast-wind drive assembly. A spring pulls it so its rubber-rimmed idler moves in against the flywheel and takeup spindle. The spindle turns at high speed. To analyze fast-forward operation, first make sure the playing assemblies have moved properly. Then concentrate on fast-forward. If the takeup spindle doesn't spin smoothly, you have three possible suspects: the tension spring, a bent or binding fast-wind lever, or dirty driving surfaces.

**Step 8.** Rotate the function knob to Rewind. The roller on the fast-wind lever drops into a recess in the cam, and a spring pivots the lever. A tab on the upper end of the lever moves the fast-wind assembly. A plastic pulley that is part of the assembly presses a rubber belt against the flywheel. The same belt goes around the pulley and the supply spindle, driving the spindle backward at high speed. A malfunction in Rewind might be caused by a faulty fast-wind lever spring. The belt could be worn or stretched.

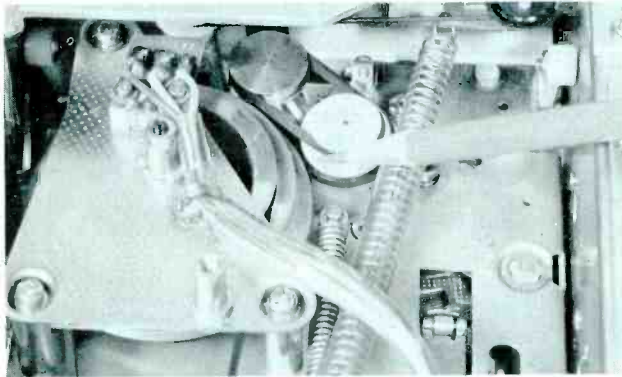
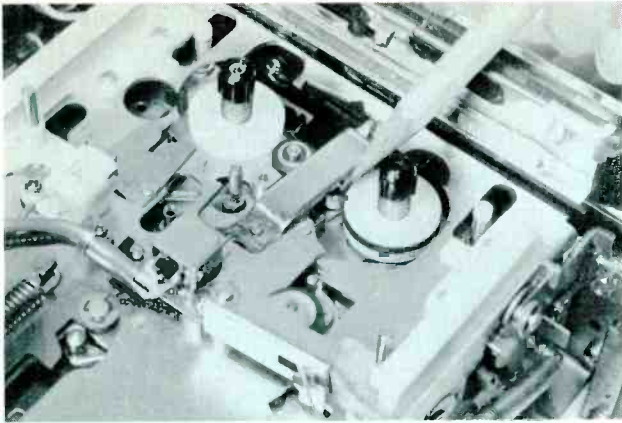


**Step 10.** As the mechanism tray swings to the rear, a rubber-rimmed idler wheel presses against takeup spindle and flywheel (or capstan wheel, in some units). A spring near the wheel, under the baseplate, maintains this contact. Naturally, if the spring is weak or has been knocked loose, tape takeup becomes erratic. The same symptom might result if the idler lever twists.

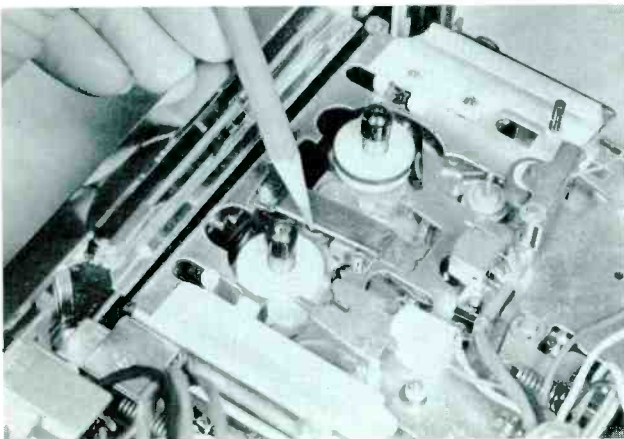


**Step 9.** The latest popular type of cassette mechanism is called slot-loading. Theo Staar engineered the technique. To make this unit play, you simply push a cassette as far as you can into the front slot. The cassette nudges two plastic guides, which move on strong steel pins that are anchored to the mechanism tray. As the guides move back, the entire tray moves toward the rear of the main chassis. Four plastic arms, slung between mechanism and main chassis, pivot the tray and mechanism upward, raising the spindles and capstan into the cassette. Two spring-loaded guide pins hold the cassette firmly positioned. If the tray doesn't move back and up smoothly when you insert a cassette, suspect a bent or warped tray. More likely, one of the pivot arms has come loose.

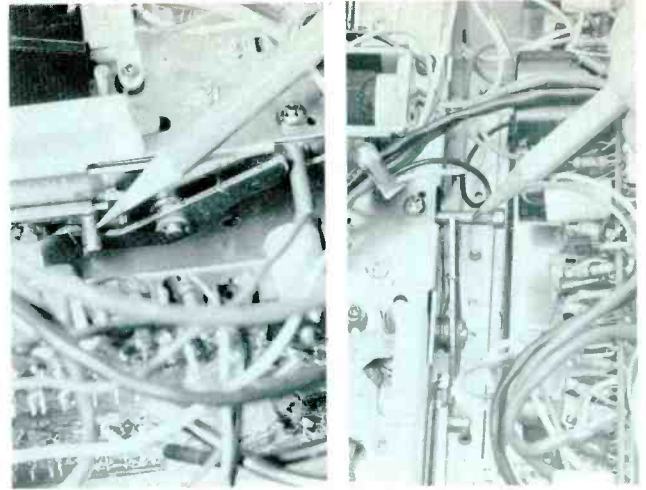
**Step 11.** At the rearmost movement of the mechanism, a leaf spring closes a microswitch to start the motor. At the same time, a lever on the main chassis catches a roller post, holding the tray in that rearward position. If the mechanism sometimes fails to latch, the latch-lever spring might be missing, or the post or the tab on the lever could be worn.



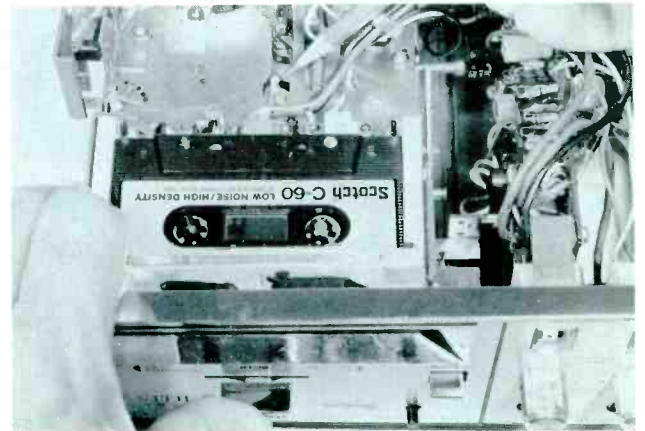
**Step 12.** There is a function knob, but it only selects Fast-Forward or Rewind operation. Push the knob left for Fast Forward, right for Rewind. In Fast Forward, a long lever pulls the entire tray forward slightly, moving capstan away from the pinch roller. The takeup pulley also pivots away from the capstan wheel and the forward (left) spindle. A hairpin spring on the function lever applies pressure to an arm, moving a metal idler against the takeup-spindle tire. Below the baseplate, a pulley/idler contacts the flywheel. A rubber belt, driven by the pulley/idler, turns a metal pulley on the other end of the fast-forward idler shaft. A weak or bent hairpin spring makes the forward spindle rotate erratically. So does a worn or dirty rubber belt. But don't overlook the drive surfaces; they might be greasy or dirty, allowing slippage.



**Step 13.** When you push the function knob to Rewind, it moves the same assemblies as for Fast Forward...except the hairpin spring pivots the fast-forward idler the other way. A small, rubber-rimmed idler goes up against the supply (right) spindle. Defects and cures are the same as described in Step 12.



**Step 14.** To record with a slot-loader, you have to hold the Record button down before you insert a blank cassette. The button moves a Record slide to the rear, changing the record/playback switch. Then, as the mechanism tray moves rearward when you insert the cassette, a lever on the chassis reaches over and latches the Record slide. If you can still push the Record button in after you've inserted a cassette, the latching lever spring might be at fault. Sometimes the large pin on the mechanism tray, which moves the latching lever out of the way, breaks off.



**Step 15.** To stop this machine manually, move the function knob to the center (Play) position, then press it inward. A roller on the function lever pivots the tray-latching lever. The mechanism swings down and forward. That opens the power switch, and drops spindles, capstan, and guide pins down out of the cassette. The plastic guides shove the cassette forward. If the mechanism bounces when the tray swings forward, the support spring probably is unhooked.

### Summary

These four cassette Workshops have exposed you to just about all you need to know for servicing cassette mechanisms. We've given examples of cleaning, inspecting, and adjusting the three basic types of mechanisms. All cassette machines employ either the pushbutton, cam-switched, or slot-loaded principles.

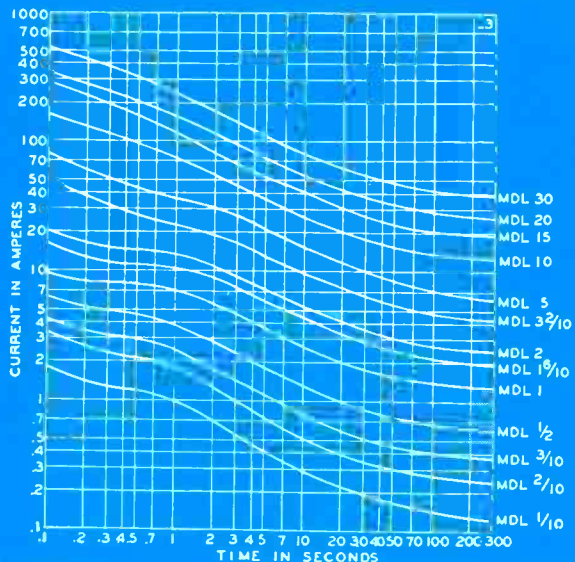
Remember: the secret of successful servicing is in the correct approach. □



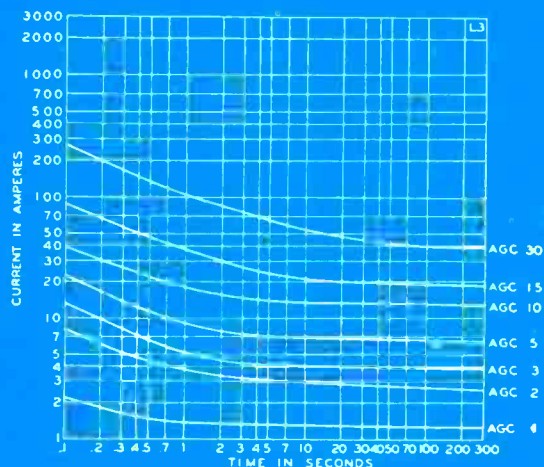
# NEED A 1/4" x 1-1/4" TIME-DELAY FUSE OR QUICK-ACTING FUSE?

# BUSS HAS IT!

Time-current characteristics of FUSETRON® dual-element time-delay fuses



Time-current characteristics of BUSS® fast-acting fuses



### FUSETRON® dual-element fuses

Time-delay characteristics avoid nuisance openings from starting currents or surges—yet, give full protection from short-circuits or dangerous overloads.

Voltage	Symbol	Amperes
250 or less	MDL	1/100, 1/32, 1/16, 1/10, 1/8, 15/100, 175/1000, 3/16, 2/10, 1/4, 3/10, 3/8, 4/10, 1/2, 6/10, 7/10, 3/4, 8/10 or 1
250 or less	MDX	1-1/4, 1-1/2, 1-6/10, 1-8/10 or 2
125 or less	MDL	1-2/10, 1-1/4, 1-1/2, 1-6/10, 2, 2-1/2, or 2-8/10
125 or less	MDX	3, 3-2/10, 4, 5, 6-1/4 or 7
32 or less	MDL	3, 3-2/10, 4, 5, 6-1/4, 8, 10, 15, 20, 25 or 30

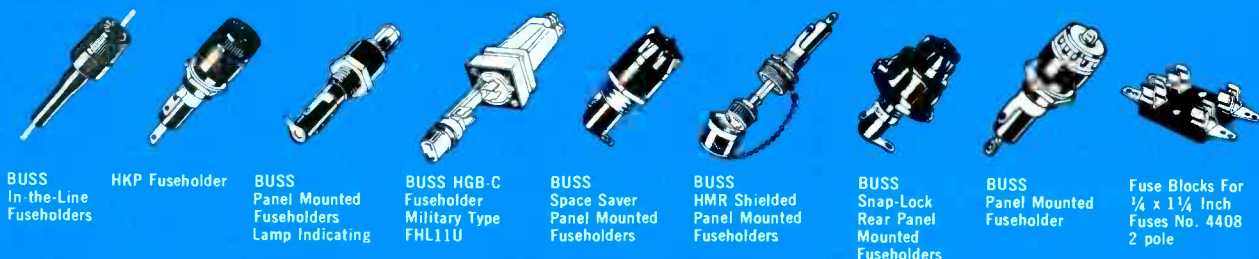


### BUSS® fast-acting fuses

Fast-acting characteristics provide the instantaneous high speed opening necessary to protect sensitive instruments or delicate apparatus.

Voltage	Symbol	Amperes
250 or less	AGC	1/500, 1/200, 1/100, 1/32, 1/16, 1/10, 1/8, 15/100, 175/1000, 3/16, 2/10, 1/4, 3/10, 3/8, 45/100, 1/2, 6/10, 3/4, 1, 1-1/4, 1-1/2, 1-6/10, 2
250 or less	MGB	1/16 or 1/8
MBW & MBB fuses now called AGC.		
250 or less	AGC	2-1/2, 3
250 or less	MTH	4, 5 or 6
For 250 volt fuses above 6 amperes—See ABC fuses.		
125 or less	GLH	7, 8 or 10
32 or less	AGC	4, 5, 6, 7, 7-1/2, 8, 10, 15, 20, 25 or 30

For a complete selection of BUSS fuses and fuseholders ask for bulletin SFB.



BUSS In-the-Line Fuseholders

HKP Fuseholder

BUSS Panel Mounted Fuseholders Lamp Indicating

BUSS HGB-C Fuseholder Military Type FHL11U

BUSS Space Saver Panel Mounted Fuseholders

BUSS HMR Shielded Panel Mounted Fuseholders

BUSS Snap-Lock Rear Panel Mounted Fuseholders

BUSS Panel Mounted Fuseholder

Fuse Blocks For 1/4 x 1 1/4 Inch Fuses No. 4408 2 pole



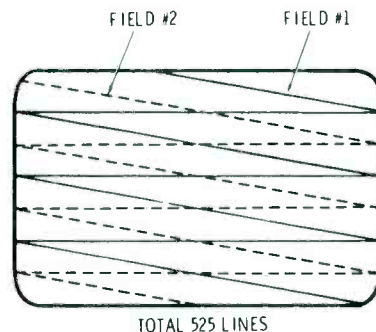
BUSSMANN MANUFACTURING  
a McGraw-Edison Company Division  
St. Louis, Missouri 63107



# Interlaced Scanning... *Both Fact And Myth*

**By Carl Babcoke**

*Yes, interlaced scanning of alternate vertical fields is possible, although few home receivers seem able to achieve it properly. Even more important than interlaced scanning is the additional knowledge about vertical and horizontal locking obtained by studying the vertical-sync interval.*



*This is a simplified drawing of interlaced scanning.*

My article entitled "Interlaced Scanning...Fact Or Myth?" appeared in the August, 1974 issue of *Electronic Servicing*. Included were all of the visual, scope, and photographic facts I had collected in a sincere effort to answer the question for myself. The final sentence asked the readers if they could **prove** that vertical fields actually interlaced.

Thanks for all the letters; there were too many for personal replies. All the letters were interesting, and many were very helpful. Some excerpts will be included near the end.

## **Are The Vertical Fields Interlaced?**

Here is a summary of the conclusions I arrived at after studying the letters and doing more research:

- The composite video signal, as broadcast from any commercial TV station, **has** the characteristics necessary for interlace at the receiver;

- Specialized monitors in the control rooms of TV stations **do** exhibit perfect interlace (when correctly adjusted);

- **None** of the home-type TV receivers I have observed during the past few months have shown more than a hint of interlace; and

- Surprisingly, sharpness of the picture is not degraded significantly if the fields are not interlaced.

Before all you technicians (who have never seen "line-pairing" except with poor detail) rush to dispute that last statement, let me explain. The line-pairing does not **cause** the poor detail; rather, both are parallel symptoms of another defect.

Simple failure to interlace, when there's no other defect, looks very normal to us; it's the usual condition. If a modern color receiver started interlacing while we watched, we would swear it went out of focus, because the scanning

lines would disappear. Don't believe it? Then read on.

## **Scope Traces Of The Fields**

Photographing the vertical-sync areas of video from the screen of a scope can be very frustrating. First of all, the scope must have triggered-sweep, and preferably dual-trace. When used for viewing the usual horizontal and vertical rates, triggered scopes are rock-steady. But when pushed to the limits by magnification of small segments of the signal and full expansion of the trace width, even excellent scopes begin to show some instability. Also, all video waveforms taken from a TV receiver move up and down in centering and vary in height as the scenes change. Expansions of the width and scanning small portions of the waveform reduce the brightness of the trace, and this is decreased even more by dual-trace operation. Add the dim traces, the video movements, and the necessity for long camera

exposures of 2 to 15 seconds and you can get some idea of the problems.

Even so, **I strongly recommend these tests to you as an excellent method of learning about video and sync characteristics.**

There is one method of viewing the vertical-interval segments of each field separately when the scope is not dual-trace. The method is detailed in Figure 1. It has the advantage of showing the entire vertical interval, including the pre-sync equalizing pulses and the Vertical Interval Test Signals (VITS). But there's a limitation. The amount of expansion is not enough to permit detailed inspection.

#### Identifying the fields

How can we determine which of the fields shown by the scope is Field #1 and which is Field #2? There are three differences between fields: only one has a blanked-out half line of video at the top of the picture; the VITS of one has the multi-frequency bursts, the other has "stairsteps"; the first normal horizontal-sync pulse is only a half line away from the last post-sync equalizing pulse, while the other has a full-line space. Figure 2 shows all these conditions in the ways normally considered correct. The top trace is Field #1, and has: the narrow space between the equalizing pulse and the first horizontal-sync pulse; the multi-frequency bursts; and the half line of video.

**Only the half space between the last equalizing pulse and the first horizontal-sync pulse is totally trustworthy for identification of Field #1;** the others are allowed tolerances according to FCC rules. Some of the variations I have noticed are given in Figure 3.

#### Wrong Sync Positions

There is one inherent error in all these dual-trace waveforms: Field #2 is displaced to one side of the correct position, making the vertical sync pulses lined up one above the other, and the horizontal-sync pulses alternated. **The error is caused by the nature of dual-trace tests.**

When you operate a scope in dual-trace mode, you should adjust the scope so locking is taken **only** from one channel, usually #1,

otherwise the relative phase of the two traces might drift and cause errors. In these interlace tests, the same video signal is applied to both scope channels. For the first trace, Field #1 is present in both channels, but is viewed and locked only on channel 1. Then, for the next alternate trace, Field #2 is present in both channels, but is viewed on channel 2 and locked by channel 1. Therefore, each trace starts at the same point of the vertical sync for both fields. They **appear** to have the same phase, but for interlace to happen, one **must** start before the other. I don't want to admit how long I studied the problem before the reason for the wrong scope phase finally dawned on me.

From the screen of the picture tube, we can see that the horizontal-sync pulses and the horizontal scanning lines with video are (and obviously must be) arranged in

straight vertical columns.

Therefore, to obtain a correct scope picture showing the relative phase of the two vertical-interval segments, we must move Field #2 (Figure 2) either to the right or to the left by one-half horizontal scanning line. Which direction should it be moved?

The answer can be found in the position of the VITS in each field. The scope waveforms of Figure 3 show the VITS of Field #2 apparently to the right of Field #1 VITS by one-half horizontal scanning line. Yet any receiver that interlaces shows them lined up vertically, and those not interlacing show perfect merging of the VITS of lines 19 and 282.

#### Scope Error Corrected

So, to correct the scope error, we **must shift Field #2 one-half horizontal line to the left**, as shown in

### Why Learn About Interlace?

No doubt the thought has come to you (as it has to me) that, if all these receivers produce an acceptable picture with an interlace of perhaps 10%, why should we be concerned about the subject? There are several reasons why it's important.

One reason is in the future. The goal is to have "pictures-on-the-wall" screens in large sizes. Think about those scanning lines as large as pencils that would result without interlacing of a 4X5-foot picture. Either a completely-new system of TV must be started (and all old sets made obsolete) or these new futuristic receivers **must** have perfect interlace.

Another reason is to correct errors where we find them. Text books and exams have many explanations or answers in them that are correct under certain conditions. When the conditions are not stated, many of these principles are wrong, or could be wrong. Most books I have examined are completely wrong in explanations of vertical and horizontal scanning and the reasons for the waveforms. And I was amused by a statement in the December issue of one magazine that one vertical field has 262 lines, and the other has 263!

But the important reason for us in the service business is that sync pulses of various widths are used eventually for locking both horizontal and vertical sweep systems. Unless we understand **why** and **how** this is done (and why defects or extraneous pulses can defeat it), our servicing of the locking systems must be haphazard and inefficient. That's why I have included some practical examples. □

the drawing of Figure 4. This drawing is the same one that was used in August, but with several additions and changes. Here the start of Field #1 is at the pre-sync equalizing pulses instead of the start of the serrated sync pulse; the vertical sync is shown correctly as one pulse with serrations, instead of six separate sync pulses; horizontal sync pulses of the two fields are lined up vertically; and Field #2 starts before Field #1. As we shall see later on, Field #2 starts first in the "hammer" seen on the picture tube.

#### Pulse widths

Widths of the various pulses can be seen on a good triggered scope (Figure 5), although the method strains the limits of scope brightness and the ability of film to capture it. About three horizontal scanning lines are shown, so this means the scope was showing a

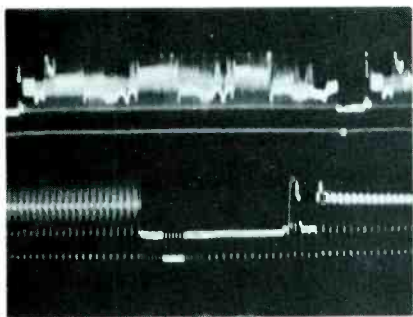


Fig. 1 Waveform at the top was obtained with the sweep locked to the vertical sync pulse by the internal sync separator in the scope. The sweep was about 1.9 microsecond and slightly more than one vertical field is shown (camera exposure for ASA 3000 film was F22 for 2 seconds). To obtain the lower trace, the X5 width button was pulled, and the horizontal centering changed to move the right-hand vertical interval to the center of the screen. Brightness dimmed because of the 5-times wider trace, and it required a 6-second camera exposure. Refer to Figure 6, page 13 of August, 1974 issue for an explanation of the various parts of the waveform. According to the VITS and the spacing between equalizing and sync pulses, it is Field #2. If you want to see Field #1, just throw the scope out and in lock until Field #1 appears. This lower waveform can be obtained by almost any triggered scope with an X5 switch; however, no additional expansion of the vertical interval is possible. For more, dual-trace and alternate-sweep functions must be used.

trace for only 3/262.5 of the time. No wonder the waveform was dim!

I doubt if the width of the serrations that divide the vertical sync pulse is important, so long as it's not too wide; a change of DC is required here. However, there are twice as many equalizing pulses as horizontal-sync pulses, so the width of the equalizing pulses **must** be exactly half the width of normal horizontal-sync pulses, to prevent any undesired shift of the zero line during the time of the equalizing pulses.

#### Interlacing Versus Horizontal Locking

If we consider nothing but the information shown in the drawing of Figure 4, it seems that interlacing of the vertical fields not only would be possible, but is mandatory. It's certain that the horizontal oscillator in the receiver should be controlled correctly so it would fire alternately through the two fields, as shown. But before we go to the vertical problem, let's take an informative detour through horizontal locking.

#### Equalizing pulses

It's likely better vertical sync could be obtained if there were no equalizing pulses. But that would allow the horizontal oscillator to run wild during these times, causing "hooking" of vertical lines at the top of the picture. So the pulses must be there, but they are made narrow. Also, two equalizing pulses must be present during each horizontal-scanning line. One reason, already mentioned, is to prevent any shift of the zero-voltage line. The other reason is to provide an extra horizontal-sync pulse for oscillator control for those times between the normal horizontal-sync pulses. Figure 4 shows how the two fields use different equalizing pulses for oscillator control. Any pulses occurring in the middle of a line are ignored by the set's AFC circuit.

#### Why differentiate the sync?

All horizontal AFC circuits in TV receivers feed the output signal from the sync separator through a small-valve capacitor to the phase diodes (or other control circuit). This high-pass filter action is necessary because of the three widths of

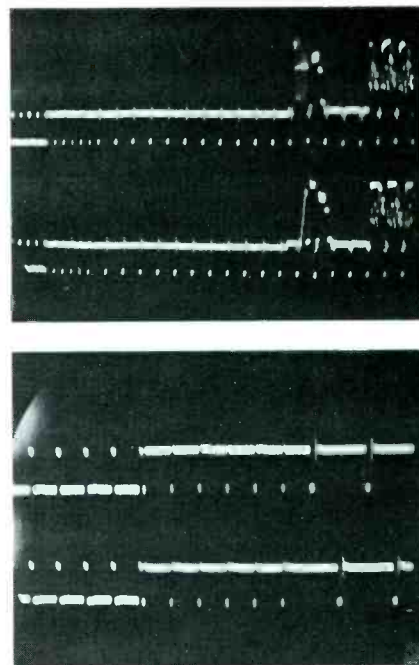


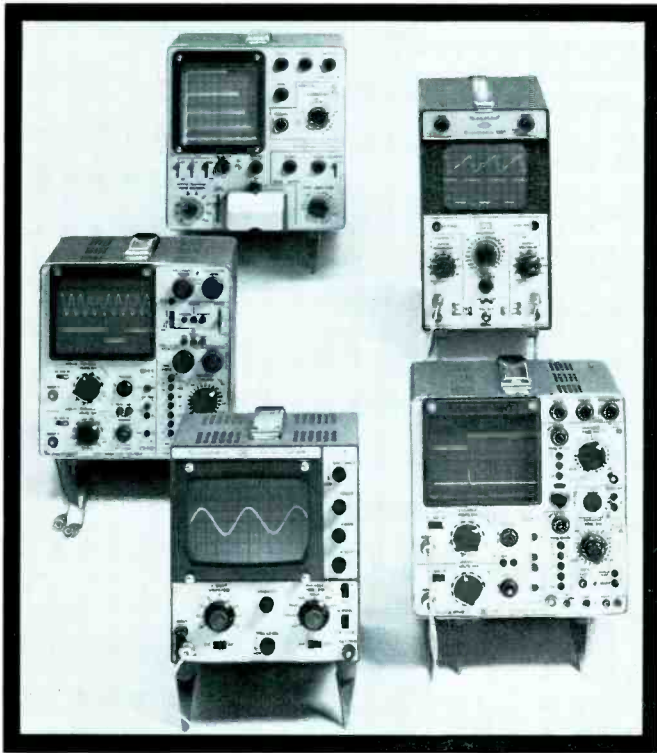
Fig. 2 Dual-trace and alternate-sweep functions of the scope were selected, both probes were connected to the video detector of an old color TV, and the scope was locked by using the internal sync separator. In both pictures, Field #1 is at the top, and Field #2 is the bottom trace. (A) Horizontal sweep time was about .15 milliseconds, and the low brightness required a camera exposure of 4 seconds at F16. Although the pre-sync equalizing pulses are missing, along with a serration or two of the vertical-sync pulse, the waveform is greatly expanded compared to that of Figure 1. Even more expansion is possible. (B) Scope sweep was changed to 30 microseconds and the exposure was 10 seconds at F16. Now the half-space between the last equalizing pulse of Field #1 and the first horizontal-sync pulse clearly is visible.

pulses used for sync. After sync separation, the pulses are the same relative widths as those shown in Figure 5. It certainly would foul up horizontal locking if these various pulses were allowed into the AFC circuit. The solution is to differentiate the pulses into narrow spikes whose widths are constant regardless of the widths of the input waveforms.

An example can be simulated with square waves (Figure 6). The differentiated pulses had nearly the same height and width, even though the frequency of one signal was six times that of the other.

This constant-width action permits the horizontal oscillator to lock to the leading edges of the

# Why You Should Buy Telequipment...

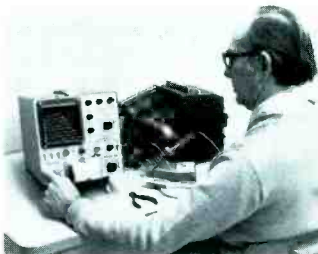


Telequipment instruments can be your best buy for trouble-shooting consumer electronic products at the bench or in the field, for many laboratory applications, for manufacturing production control, for student labs, and for broad areas of design engineering—virtually any price-sensitive area of application where the instrument specifications meet user demands. The performance and reliability of Telequipment instruments are well established.

The D61 10-MHz dual-trace oscilloscope, for example, has been acclaimed by independent experts for its "unique features and superior performance." (Use the coupon for a copy of the article, *Reports from the Test Lab.*) The D61 is chosen as a quality 10-MHz dual-channel oscilloscope throughout the industry. TV line or frame triggering and provisions for X-Y vector patterns make the D61 especially well suited to consumer product ser-

vice shops. Its stable triggering characteristics, front panel simplicity, and versatility make it an excellent choice for industrial and educational use, as well.

The Telequipment line also includes the DM64 10-MHz dual-channel storage oscilloscope, the exceptionally low-priced S51B 3-MHz oscilloscope, and more. There's an easy-to-operate transistor curve tracer, the CT71, that has wide application in schools and design labs.



The D67 oscilloscope combines dual trace, 25-MHz bandwidth, FET inputs, regulated power supplies, and all solid-state circuits with delayed sweep capability—a combination of features seldom found in such a low-priced oscil-

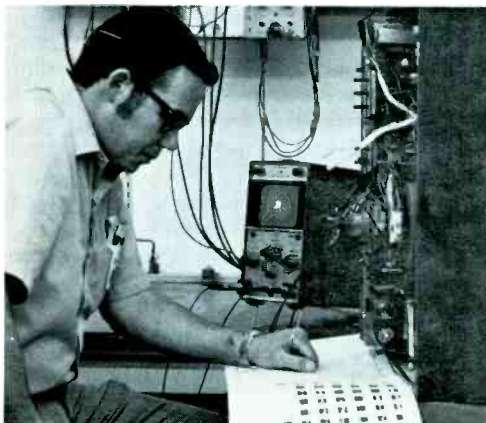
loscope. (Ask for the D67 article reprint, *Another Step Forward.*) Its sister scope, the D66, offers all features but delayed sweep at an even lower price. Both feature a SUM mode with normal/invert capability that improves visibility of small signals in the presence of common mode noise.

Tektronix supports Telequipment with its full corporate services and network of field engineers, providing complete specifications, applications notes, consultation and demonstrations, and warranty. Consider the prices as well...

Model	Features	Price
<b>S51B</b>	3 MHz, Single-Channel	\$ 325
<b>D61</b>	10 MHz, Dual-Channel with X-Y	545
<b>CT71</b>	Curve Tracer	895
<b>D66</b>	25 MHz, Dual-Channel	875
<b>D67</b>	25 MHz Dual-Channel, Delayed Sweep	1,125
<b>DM64</b>	10 MHz, Dual-Channel, Storage	1,195



There are many good reasons why you should buy Telequipment—some general, some specific. To learn more, contact your local Tektronix Field Engineer or write Tektronix, Inc., P.O. Box 500, Beaverton, Oregon 97077. In Europe, write Tektronix Ltd., P.O. Box 36, St. Peter Port, Guernsey, Channel Islands.



## I want to learn more about Telequipment instruments:

Name \_\_\_\_\_ Title \_\_\_\_\_

Company \_\_\_\_\_

Address \_\_\_\_\_

City \_\_\_\_\_ State \_\_\_\_\_ Zip \_\_\_\_\_

- I would like the full specifications on Telequipment instruments.  
 I want a demonstration of \_\_\_\_\_, so have a Tektronix Field Engineer contact me.

I want the independent magazine article reprint on the  D61  D67.

ES/2/75



**TEKTRONIX**  
 committed to  
 technical excellence

sync pulses, regardless of their original width.

#### Locking problems

Horizontal locking theoretically should be perfect, even during the vertical-sync interval. But the different widths of sync pulses presented to the sync separators can cause problems.

For example, all input signals to sync separators have a deliberate attenuation of high frequencies (apparently to reduce the effects of noise). Each segment of vertical sync is about five times as wide as a horizontal-sync pulse and ten times as wide as an equalizing pulse. Therefore, a loss of highs affects the equalizing pulses the most. Strong vertical sync pulses would charge the peak-reading capacitor feeding the grid or base of the sync separator. Then the weaker equalizing pulses that follow could not cause conduction. This loss of horizontal sync during the time of the equalizing pulses allows the horizontal oscillator to run wild for a time, and perfect phase is not restored until after the start of the video for the picture. The result is a bend (or "hook") at the top of the picture.

#### Peculiarities Of Vertical Sync

Usually vertical sync is explained by saying each field has six vertical-sync pulses which charge up the integrator capacitor making one pulse used to fire the oscillator. **That theory is partially wrong!**

#### One pulse versus six

Mr. C. Bailey Neal, Manager of Advanced Developments at GTE-Sylvania, corrected me about the number of vertical-sync pulses. Each vertical field has just **one** sync pulse that has narrow serrations dividing it into six parts. As explained, the leading edges of each segment act to synchronize the horizontal oscillator. Waveforms should prove whether or not the serrated segments act together as one pulse to the vertical.

The waveforms of Figure 7 show what happen to square waves of TV vertical and horizontal scanning frequencies when they pass through an integrating filter (a low-pass circuit with a series resistor, then a capacitor to ground). A time constant that barely rounds the corners

at 60 Hz, leaves only a tiny ripple of 15,000-Hz triangular waveshapes (pulses integrate into sawteeth). This proves that horizontal-sync and equalizing pulses can be filtered out without significant change of vertical-sync waveforms.

#### Integrating various waveforms

If the six segments of vertical sync are to function as one, they should integrate in the same way as a non-segmented pulse. The integration of a vertical-sweep pulse closely resembled the actual TV sync signal following a one-section integrator (Figure 8), even though the pulse shown was narrower and more pointed at the tip, and the serrations seemed to cause a slightly-slower build-up of the sync pulse. After integration, the sync pulse followed the general classical curves of the charging and discharging of RC time-constant circuits; and this proved the existence of only **one** vertical-sync pulse per field.

#### How Can The Vertical Fail To Interlace?

Nothing in the preceding information indicates any reason why the vertical sweep should fail to interlace. According to theory, it should operate without a hitch. But we live in a real world with unanticipated problems. The flaw in this ingenious system is that non-sync horizontal pulses accidentally finding their way into the vertical-sweep system can upset the carefully-planned phase relationship of Field #1 and Field #2 sync pulses.

Examine carefully the two pictures of Figure 9. One shows video with part of the vertical sync pulse and several following equalizing pulses of Field #1 compared to the corresponding horizontal-sweep pulses. The other picture gives the same waveforms for Field #2. These waveforms were simulated (remember the scope-locking problem), but they are correct. Although video is shown, the sync pulses after separation will have nearly the same appearance.

Now, assume a mixing of the sync and sweep waveforms. The sync pulses are negative-going and the horizontal pulses are positive-going, so a mixture results in partial cancellation of the sync pulses. Certain corners of segments of the vertical sync pulse are

eliminated by the cancellation.

Although the first segment of vertical sync is not shown in Figure 9 (it's lost in locking the scope), we can imagine the location and the position of the corresponding horizontal sweep pulse. Therefore, the

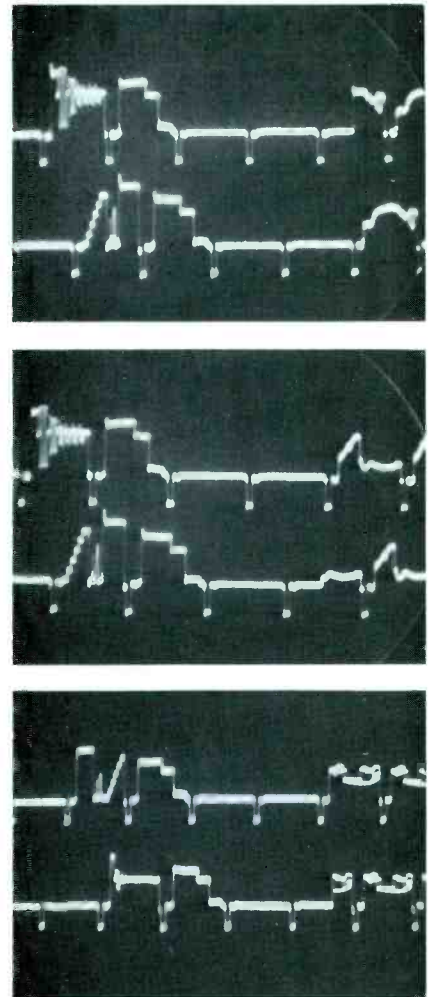


Fig. 3. Several variations have been noticed about which lines the VITS occupy, the type of VITS, and which field and line has the half-line of video. In all three waveform photos, the top trace is Field #1, and Field #2 is at the bottom. (A) This display seen on NBC is considered to be normal. Field #1 has  $2\frac{1}{2}$  lines without video, and Field #2 has two. Notice that both fields are blanked at the same lateral point. Apparently the blanking function at the network operates somewhat the same as the scope locking does. (B) At another time, an NBC program had the half-line of video in Field #2, with only 2 lines without video following VITS in Field #1, and  $1\frac{1}{2}$  lines in Field #2. (C) This example taken from a CBS program has the "stair-steps" in Field #1, and a different kind of multi-burst plus a half-line of video in Field #2, but the blanking is not in the center of the line.

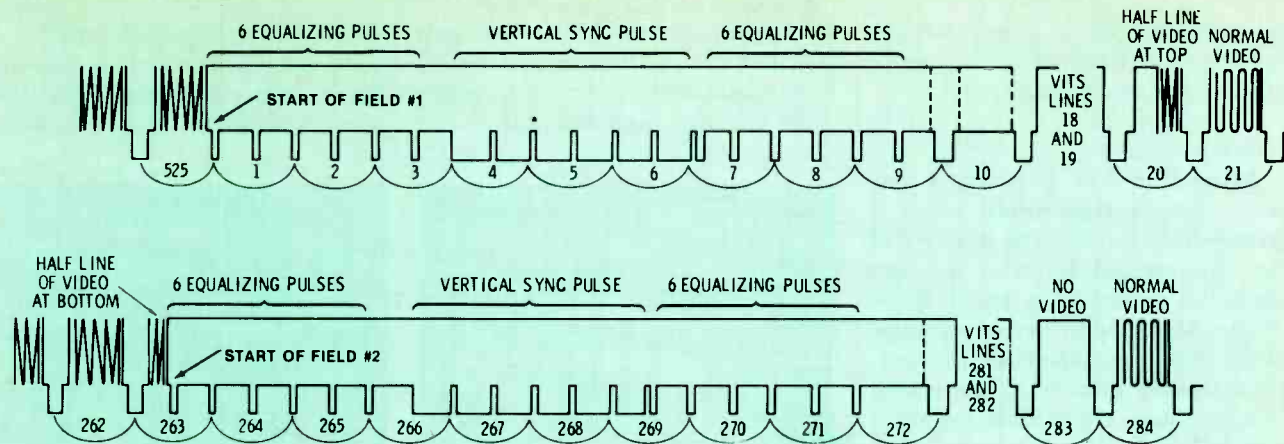


Fig. 4 Although the widths of the various pulses are not drawn to scale, this drawing gives a clear idea of the phase differences between the vertical intervals of the two fields, and shows which pulses control the firing of the horizontal oscillator in the TV receiver. Receiver vertical retrace of Field #1 starts at the **end** of line 6 and is completed by lines 10 or 11 (approximately). Vertical retrace of Field #2 starts in the **center** of line 269 and is over by about line 274. That's where the half-line of the 262.5 is obtained, not by horizontal deflection of a half-line. The visible half-lines at the top and bottom of an actual picture are created by blanking, not sweep.

leading corners of segments #1, #3, and #5 of the vertical sync for Field #1 will be cancelled partially. Also, in Field #2, segments #2, #4, and #6 will have partial cancellation. These waveforms are shown in Figure 10.

#### Proof from waveforms

For years, I have known that horizontal pulses getting into the vertical-sweep system could cause a shimmy (a 30-Hz up-and-down motion of the entire picture). Scope analysis of the vertical-sync pulses showed them to be weakened, but alternate ones were even more weak (top picture of Figure 10). The vertical would lock on the stronger pulse, start to roll on the next weaker pulse, lock with the next strong one, etc. The result was a shimmy.

At that time, I mistakenly believed that one of the two "hammers" mentioned in the previous article was for Field #1, and the other was for Field #2. If true, there could have been no horizontal-sweep pulses during the hammer that occurred in the center of the picture, but the sweep pulses would have happened during the time of the other hammer, and any mixture would have partially cancelled the sync for that field.

Unfortunately, that theory was wrong. Each hammer visible on the TV screen has in it sync and equalizing pulses of **both** fields.

The bottom picture of Figure 10

has a comparison of normal vertical sync (following a one-stage integrator) and the distorted sync pulses of Fields #1 and #2 when horizontal-sweep pulses were present. No longer are the pulses identical. In addition to the different amplitudes, one has maximum amplitude near the beginning of the pulse, while the other reaches maximum near the end.

These distortions were magnified by the application of large amounts of interfering sweep pulses (although this amount can be found in sets that shimmy). However, far less distortion of the pulses can cause a loss of interlace. The effect is to tilt the sync pulse of Field #1 in one direction, and the pulse of Field #2 in the other; the result is that both sync pulses have about the same phase. **Any sweep controlled by such sync pulses would trace both fields over the same set of horizontal scanning lines; interlace would be eliminated.**

#### Search For Truth

Some of the first letters to arrive, after the August article reached the readers, mentioned the pulse-cross display available at TV broadcasting stations. I visited two of our local stations and photographed the display.

In a pulse-cross monitor, the vertical and horizontal sync pulses are changed in phase so when the picture is locked the areas usually occurring during vertical and hori-

zontal retrace are shown on the screen, and the height is increased to about three times the normal amount. This gives a picture that resembles a cross lying on its side, and with the scanning lines spread apart for easier analysis of the interlaced scanning.

#### At last, interlace!

Yes, the fields of the pulse-cross monitor were interlaced perfectly. There were six scanning lines in each hammer of the vertical sync, and six equalizing pulses on each side of the sync, as shown in Figure 11. Correct widths of all the pulses can be seen easily.

Two amusing incidents happened. At one station, I asked if the monitor had a vertical-hold control, with the hope that adjusting it would show the visible results of interlacing versus non-interlacing. The chief engineer recoiled in mock horror. It seems the expensive monitors don't produce interlace automatically, but require careful adjustments.

An old b-w monitor at the other station had excellent detail, but could not be forced to interlace (there's no guesswork with the pulse-cross display). In all fairness, I must say the station had a new color monitor in the main control room; that monitor had perfect interlace. The old one was in the transmitter room where interlace was of no importance.

The point is: interlacing of the

two vertical fields is a very delicate condition, and not something automatic and unchangeable.

#### A correct diagram

Assured by the pulse-cross displays that interlace **could** occur, I returned to studying the drawing of the two vertical intervals as they might be viewed of a super scope (Figure 4), trying to devise a similar chart for a pulse-cross picture. Even looking directly at the screen of a monitor, it's difficult to trace each individual line. And even a big and sharp picture did not allow enough room for the labeling of all the important lines.

Finally, I became convinced that alternate lines of **both** hammers were used for the two fields. Also, that the first equalizing pulse of Field #2 was the start of it all, and it was located in the hammer at the right (the one seen by rolling the vertical of a normal TV). The first equalizing pulse of Field #1 started one-half line later in the left hammer of the pulse cross (the one occurring during horizontal retrace in a normal TV set.)

I had a rough drawing about finished, when another letter mentioned a book with much information about interlace. I borrowed a copy of "Television Broadcasting Equipment, Systems, and Operating Fundamentals" by Harold E. Ennes (Howard Sams book number 20786), and with mixed feelings (like a man who just discovered someone else had beat him to the invention of the wheel) I found the exact diagram I wanted on page 293. The book department of Howard Sams loaned us the original art work, reproduced here as Figure 12. Study it carefully; perhaps it's the only completely-accurate chart of the pulse-cross display.

#### Facts And Flack From Readers

Here are a few comments and quotations from reader's letters:

- "Your waveforms prove that proper time relationships exist in the transmitted signal. Thus I can only conclude that...the designers of the majority of vertical and horizontal circuitry have negated the benefits to be gained from accurate interlacing. Use of interacting circuitry, such as horizontally-derived B-boost

to supply vertical linearity, and vertical cathode biasing tied to horizontal-output tube suppressor-grid circuit, plus blanking and

sweep pulses floating around on many leads, can cause many subtle happenings—including poor interlace." So wrote Ray C. Phillips,

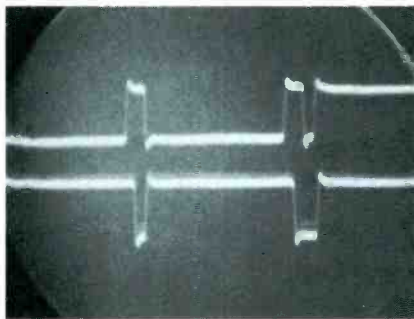


Fig. 5 This double exposure shows the width of all three kinds of pulses. Top trace has two segments of the vertical sync at the left and the first equalizing pulse at the right (the video is negative-going). The trace at the bottom has an equalizing pulse at the left and a normal horizontal sync pulse at the right.

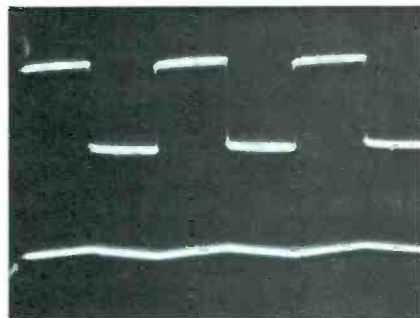
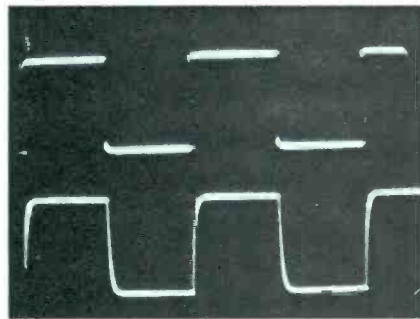


Fig. 7 Square waves illustrate that an integrating low-pass network, which merely rounds the corners of 60-Hz square waves (top picture), virtually eliminates 15,000-Hz square waves (bottom picture).

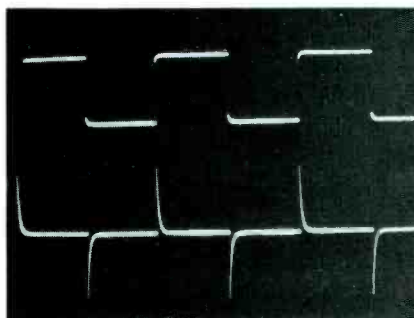
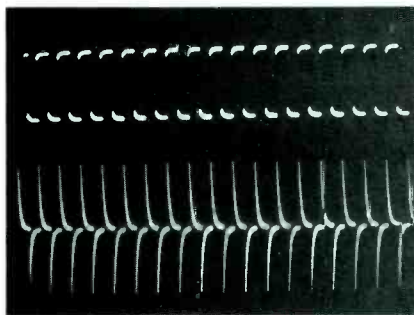


Fig. 6 Wide segments of the vertical-sync pulses will not upset the horizontal locking, if a high-pass filter is used between the sync separator and the horizontal-phase detector. The top dual-trace picture shows the source of square waves and (below) the output of the high-pass filter. In the bottom picture, square waves six times as wide have spikes that are very similar to the others when routed through the same high-pass filter. Therefore, differentiation of all sync pulses produces the same spikes from equalizing pulses, normal horizontal-sync pulses, and segmented parts of the vertical-sync pulses.

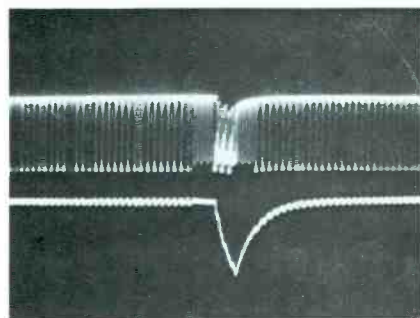
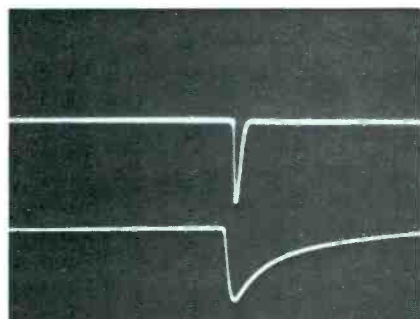


Fig. 8 Integration of a narrow vertical-frequency pulse (top picture) produces nearly the same waveform as integration of the output from a sync separator (bottom picture). This is proof that each vertical field has just one sync pulse which is segmented into six pieces.



CET, BSEE Purdue 1962, Lt. USN Retired, of Phillips Piano & Organ Service, The Dalles, Oregon.

- "Interlace occurs much as the laces in a pair of shoes...." Sorry, but the horizontal return trace is blanked out, either by station or receiver blanking, and cannot be seen. In addition, it is so rapid that it has little brightness.

- "Position of the equalizing pulses at the center of the screen convinces me that interlacing isn't a myth. I have seen sets with pairing of fields, and the picture detail was terrible. Most sets can be forced into pairing by use of the vertical-hold control", replied James Erp of Hillsboro, Illinois. At first, I too thought the center position of the hammer meant interlacing, but I was wrong. Perhaps Figure 12 will convince you.

- J. A. "Sam" Wilson, CET, well-known technical writer, commented

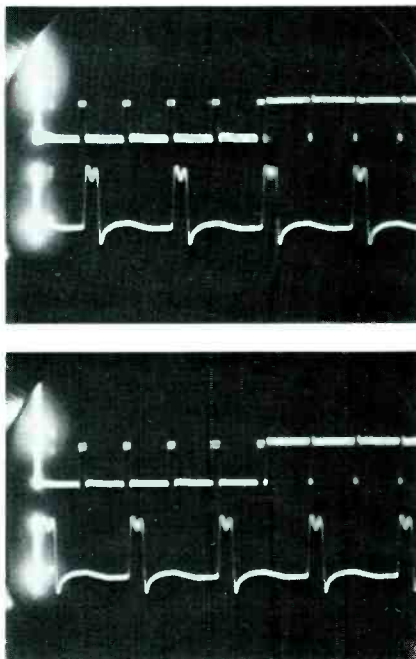


Fig. 9 Whether or not interlacing occurs, the horizontal sweep of the receiver fires at different pulses during the vertical interval of the two fields. The top picture shows the segments of vertical sync and several equalizing pulses in the video of Field #1 in relationship to the horizontal-sweep pulses. In the bottom picture, the same elements of Field #2 are shown. When sweep pulses wrongly mix with sync pulses, different sections of the vertical-sync pulses of the two fields are attenuated, thus wiping out the phase differences and preventing interlace.

in his September, 1974 issue of **Technical Notebook** that my article must be a put-on, and hinted that proof of interlacing could be obtained with a TV receiver and a square-wave generator.

- Ron Crow, of IS CET fame, consulted with Harrie Buswell and then connected a square-wave generator to the picture-tube grids (both color and b-w goes to the cathodes) of an A04 Sylvania. Careful synchronizing of the 30-Hz square waves with the picture brought about a blanking of alternate fields and a narrowing of the horizontal scanning lines. Comment: I tried this method, but was not successful. **The method is valid**, but proved to me only that the receiver I used couldn't interlace.

- Thomas M. Wimberly of WAND-TV in Decatur, Illinois wrote a 6-page letter giving in detail the steps he went through to prove with scopes, monitors, etc. that the signal at his station was interlaced. He counted the scanning lines on the screen of a station monitor and found 518, which added to 7 lines for vertical retrace totals the required 525. He also referred me to the Harold Ennes book, an excellent source of accurate information.

- From Leonard C. Blechman: "I wonder if you weren't pulling our legs? I checked several Sears b-w sets in the shop where I work and found more than 400 lines, by counting the number for one inch and then multiplying by the height. What you are counting as a line actually is two lines with a black hairline in between. It's not so easy to check with color sets because the triads of dots make the lines more blurred."

- "If in many TV sets there is no interlace, it's because manufacturers are cheap....It's too bad you cannot nail the manufacturers, since they give you sets and commercials. But if you want to know which sets have good interlace, read Consumer Reports, or go there so they can teach you"; name withheld by editor. Comments: Attached to the letter were some pages from Consumer Reports. Being as charitable as possible, and knowing that the CR articles were written for laymen, not technicians, I must say the Consumer Reports writer didn't understand interlace. He describes it as evenly-spaced

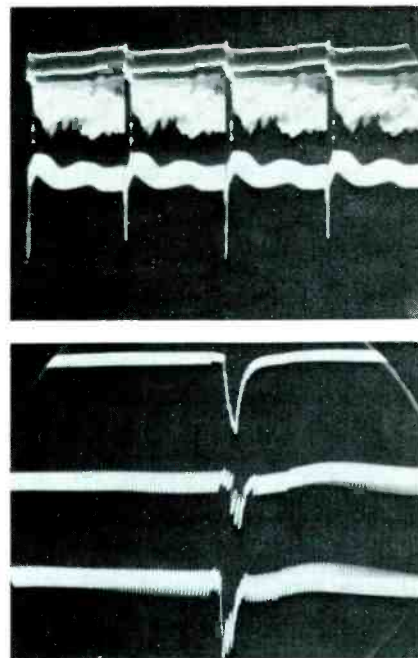


Fig. 10 Undesirable addition of horizontal-sweep pulses to the sync affects the amplitude and waveshape of the vertical sync of the two fields differently. In the top picture, video at the vertical rate is shown with the vertical-sync pulses obtained when horizontal-sweep pulses were present. Amplitudes of the stronger sync pulses are about half normal, while the weaker ones are even less. The top trace in the bottom picture is the normal vertical-sync pulse following a single-section integrator. Center and bottom traces are the vertical sync of the two fields. Notice one reaches maximum amplitude (in a negative direction) near the beginning, and the other one near the end. This gives the effect of a phase change, distorting the phases of the vertical sync pulses so true interlacing is impossible. These are three separate exposures; gain of the normal pulse was reduced to more nearly match the others, which were photographed at the same scope gain.

scanning lines. A low-priced cross-hatch generator has lines that are **very** evenly spaced, but both fields trace the **same** horizontal lines. And the manufacturers merely **loan** us TV sets and test equipment for evaluation. They are returned after tests.

- Ralph H. Carrell who works in the NBC Transmission/Switching Central department at Burbank, California corrected me about the VITS waveforms. He says the VITS are added to the video signal at the final output amplifier at the network. Also, he included information

about VITS and VIR waveforms which I will not publish until a later, and more complete, article on those signals.

- A reader living in the state of Washington roasted me real good, but he missed the whole point of the article. He has had 25 years in broadcasting, and went into detail about how the broadcast signal is generated from one oscillator with all waveforms locked together. Therefore, he believes scanning can take place **only** with full interlace, except for receivers with poor integrator circuits. The CET after my name infuriated him, yet he probably has a First Class Phone license from the FCC; certainly no less an accomplishment. One statement I must dispute is: "If we had only 262 lines in the picture, we would have a very grainy picture". The number of lines has nothing to do with grain or signal-to-noise ratio, but determines the detail possible in a vertical direction. (In fact, both fields merged into the same scanning lines probably would give even better rejection of certain beat patterns inherent with NTSC color.)

- C. Bailey Neal, Manager of Advanced Development for GTE-Sylvania, and chairman of the Broadcast Television Systems Committee of EIA (whose recommendations for a Vertical Interval Reference signal for correction of color variations has just been adopted by the FCC), sent photos taken from the screen of a broadcast video monitor, showing perfect interlace in the pulse-cross display. He pointed out the possibility of a large spot size apparently blending the lines if interlace is less than perfect; therefore, focus should be checked and brightness kept low during the tests. Interlace should vary from complete pairing to perfect interlacing as the vertical-hold control is adjusted slowly within the lock-in range. The GTE-Sylvania GT-matic receivers have digital circuits which eliminate the vertical-hold controls, and as a fringe benefit also offer perfect interlace. At first, Mr. Neal was disturbed by the possibility that the article would cause confusion where none need exist. I hope by now he agrees there are reasons to be concerned about the many times interlace does not occur.

- "Perfect interlace is possible only if every shred of horizontal (unfiltered sync, gating pulses, and sweep pulses) signal is shielded and filtered from the vertical oscillator circuit. Horizontal pulses reaching the oscillator cause one field to have 262 lines and the other to have 263, and without interlace. Perfect interlace has the raster lines barely touching; any black lines between indicate poor interlace", wrote Ronald D. Mackie of Pensacola, Florida.

- Alan F. Houghton of Dunedin, Florida commented: "Don't adjust for sharp and stable horizontal lines (using vertical-hold control). When interlacing occurs, you can't count the lines because they shimmy too much."

- Bob Baum, Director of Engineering for Sencore, gave the model numbers of the Sencore pattern generators which have a front-panel control for adjustment of interlacing. One of the problems of using interlaced scanning for the crosshatch pattern is that the horizontal raster lines give the appearance of moving. That's the reason most generators provide a field rate of either 262 or 263, and show steady non-interlaced horizontal lines. Comments: We had a Sencore CG19 generator in the Electronic Servicing lab, and I lost no time in trying it on an old color chassis. Unfortunately, this set could not be made to interlace on

any signal, either station or generator. Careful adjustment of the vertical-hold control of the receiver and the INTERLACE control on the generator would make the lines blur slightly, indicating that interlace should be possible with a better receiver. Incidentally, the starting and finishing half-line could be seen distinctly and INTERLACE control adjustments moved it across the screen. The scope waveforms of Figure 13 show the amount of movement possible.

- A broadcast engineer of Wichita, Kansas wrote: "Your point of seeing only nine lines in the "hammer" was a good one, only you missed the fact that the other hammer (located in the horizontal-retrace period) has the other nine lines. No, I'm not a CET, but if a CET couldn't see the holes in your article, he shouldn't be a CET." Comment: CET's are not required to have perfect knowledge. But you are wrong about each hammer supplying nine lines. A careful study of a pulse-cross display (as drawn in Figure 12) will show that each hammer has 18 lines **IF IT IS INTERLACING!**

### Conclusion

A summary of the things I have discovered about interlaced scanning was given at the beginning. However, many facts about test methods, results, and conclusions remain untold. A few will be given

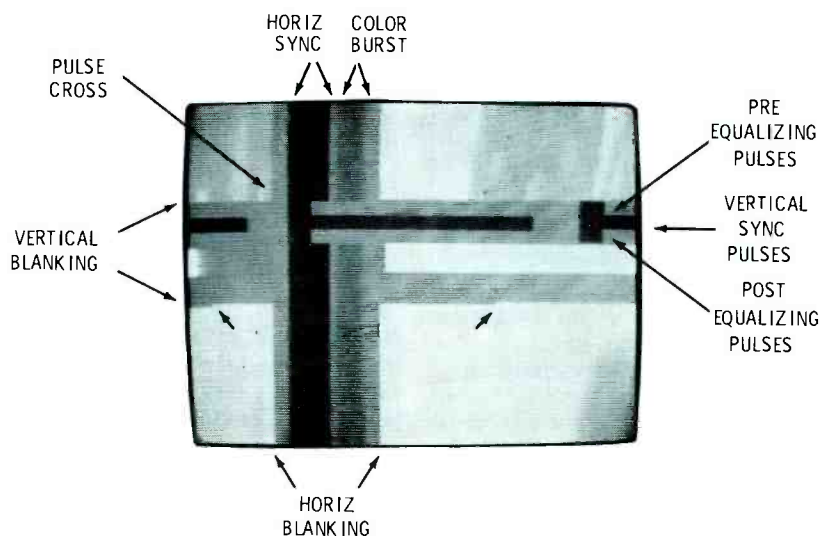
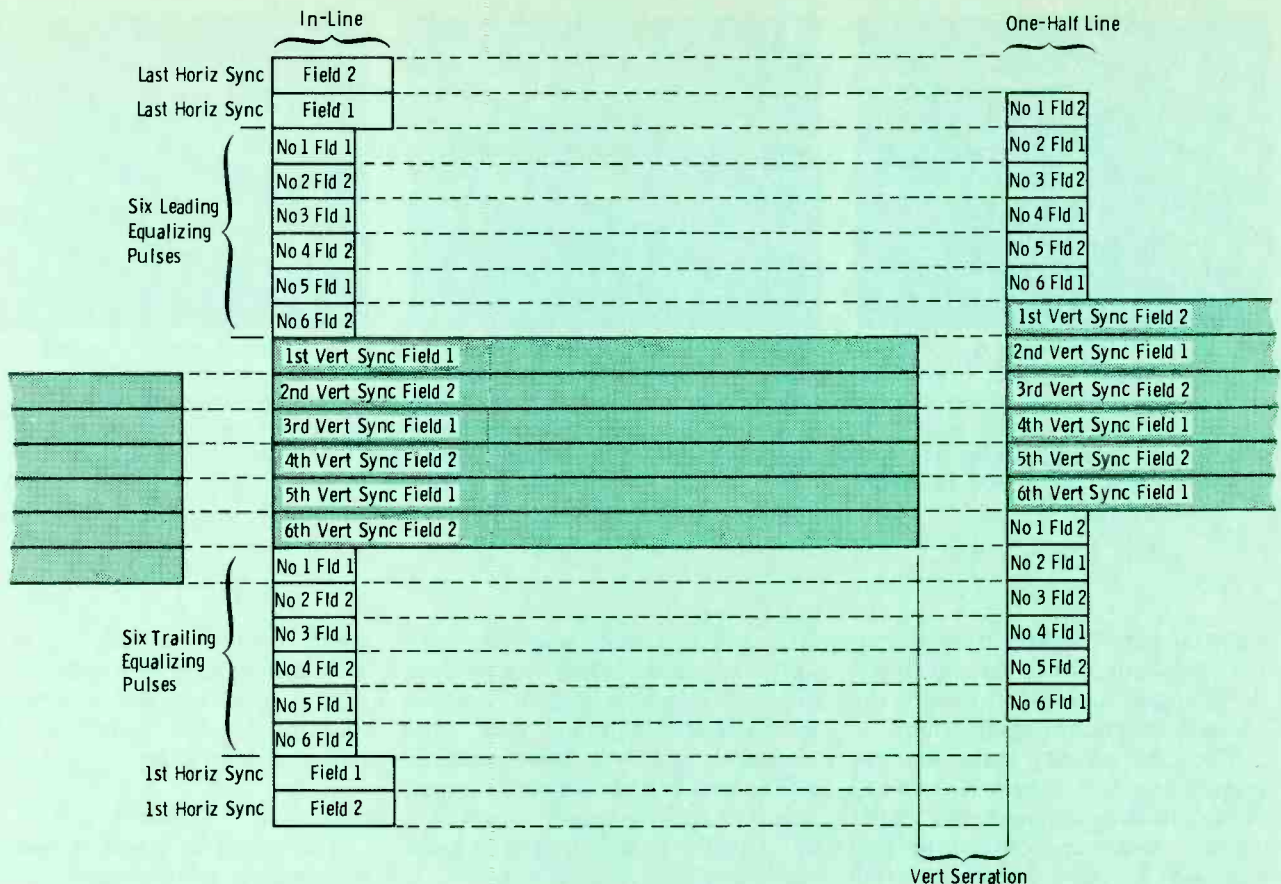


Fig. 11 Important parts of the pulse-cross display are marked on this photograph taken from a Tektronix Model 650 Video Monitor. Unmarked arrows show half-lines of video. Interlace is proven by all 18 lines in the hammer. Vertical blanking occupies 42 lines. In the monitor, sync pulses are shifted in phase to permit a stable display of the sync areas normally blanked out and not seen on receiver screens.



**Fig. 12** This chart shows the correct location on the pulse-cross display of the normal horizontal-sync pulses, equalizing pulses, and serrated vertical-sync pulses of both vertical fields. The cross on the left normally is blanked out during horizontal-sweep retrace; notice that normal horizontal-sync pulses are found **only** here. The cross at the right is the one that can be seen by reducing contrast, increasing brightness and rolling the vertical down so the blanking bar is near the center of the screen. However, this eliminates interlacing, so it cannot be used as proof. Especially notice that the first equalizing pulse is the one for Field #2, and it happens at the center of the normal horizontal scanning. Figure 4, Figure 11 and this one taken together should give you a true picture of how perfect interlace operates. (Courtesy of Howard W. Sams, Inc.)

here in the hope you will find them as interesting as I did.

#### Shutter speeds

Many technicians, including myself, questioned the use of a 1/60th of a second shutter speed in an effort to photograph just one of the two fields, because of the afterglow of the phosphors in the color picture tube. Figure 14 proves this to be a valid test, and also proves that interlaced fields are possible. Both pictures were taken with a scope camera (for convenience) from the screen of a Tektronix Model 650 TV monitor adjusted for the pulse-cross display. The picture having only 9 lines in the hammer was taken at 1/60th of a second; the short shutter time eliminated one field. The other, taken at 1/30th of a second shows a per-

fectly-interlaced raster of both fields. Only the "F" stops of the camera were changed between exposures. In the original picture, the sharpness was good enough to show individual stripes of color on the Trinitron screen.

For the pulse-cross display, the monitor increased the height by about three times. Imagine an interlaced complete picture with lines the same width, but placed three times nearer, and you can understand why we say interlacing would virtually wipe out any visible raster lines.

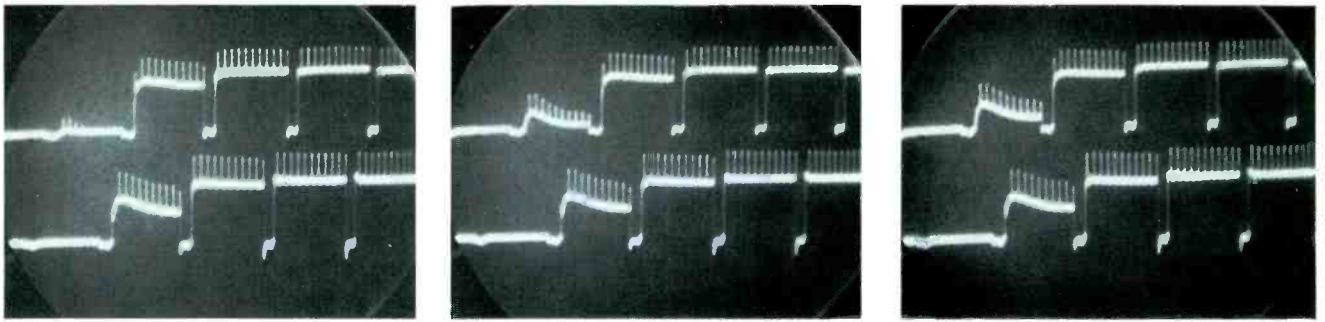
#### Why no interlace?

Only two conditions prevent proper interlace. One is an unstable oscillator with insufficient sync, producing erratic timing. The other is horizontal pulses getting into the

vertical oscillator. This latter problem is extremely difficult to prevent, and I doubt that many sets built since the early 1950's (when they had blocked-grid vertical oscillators and three-section integrator networks) have more than slight interlacing.

Perhaps the worst offender is the multivibrator oscillator/amplifier circuit with one stage also driving the vertical yoke windings. Pulses from the horizontal yoke windings reach the vertical windings in large amplitude, and then are transferred to the oscillator through the positive-feedback circuit. Of course, various bypass capacitors help, but not enough.

Some all-solid-state TV receivers have vertical multivibrators separate from the driver and output stages. However, transistors often



**Fig. 13** Variable interlacing is a feature of some Sencore pattern generators; a front-panel control is provided for your adjustment. Receiver video, when a Sencore CG19 Caddy Bar generator was the source, showed (in the left photo) the horizontal pulses of the second field moved the maximum amount to the right, the pulses centered (center photo), and moved all the way to the left (right photo). This particular receiver could not be made to interlace; however, the lines beginning and ending near the center of the picture-tube screen could be seen moving sideways as the Interlace control was adjusted.

feed unwanted signals from output back to input, either through internal capacitance or through the actual base/emitter conduction.

Then, of course, there are the huge signals of horizontal-sweep pulses floating around the entire chassis. Some are certain to find their way by stray capacitance into the vertical oscillator.

#### Effects on vertical locking

Other component defects causing soft vertical locking or vertical shimmy include:

- open AGC bypass capacitors;
- open filter capacitors; and
- open integrating capacitors.

Moderate amounts of horizontal pulses entering the vertical oscillator prevent interlacing of the two fields.

Strong horizontal pulses entering the vertical oscillator cause vertical shimmy and instability of locking.

#### Do New TV's Interlace?

Since the heretical thought struck me that TV receivers might not interlace, I have tried at every opportunity to observe or test for the amount of interlacing.

One plan was to examine new TV receivers. So I visited the sales floors of several dealers, taking along the scope camera. This camera has a close-up lens, and a light-tight hood which has the dual function of keeping out room light and providing the correct distance for sharp focus and the same magnification each time.

Pictures were taken from the screens of Zenith's, RCA's, Sony's,

GE's and Sylvania's, and later carefully examined. When the vertical-hold control of each TV was set for least-distinct scanning lines (best interlace), exposures were made at 1/30th and 1/60th. Then a comparison picture was made at 1/30th, but with the picture rolling to make sure there was no interlace.

In all cases, the pictures made at 1/60th, or when rolling, had slightly-sharper scanning lines. But none had enough interlace to show even a hint of a black space between lines, either visually or photographically.

All the receivers had evenly-spaced scanning lines and pictures with good detail, but none had any noticeable amount of interlacing. If we give these facts some thought, it's not surprising. All sets had some kind of pincushion correction,

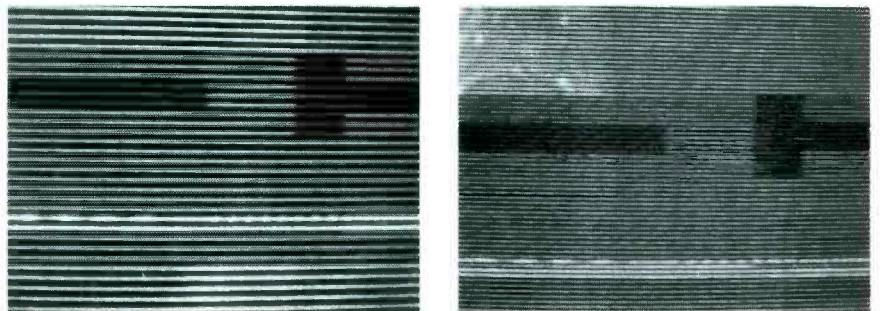
which cause a mixing of vertical and horizontal sweep signals. And only a small amount of horizontal reaching the oscillator can eliminate the interlacing.

#### Thanks

This overly-long article concludes the coverage of interlaced scanning. If anyone convinces me anything was in error, the correction will be printed. Personal replies will be given to any comments you care to make.

Thanks to Jim Schmidt, chief engineer of WDAF-TV, and to Wally Wurz, chief engineer of KMBC-TV, for their help in allowing me to photograph from the monitors.

And a hearty "Thanks" to all the readers who wrote to me about interlaced scanning. □



**Fig. 14** Here's proof of two things: first, interlaced fields are possible; and the afterglow time of at least some color phosphors is short enough for faster camera shutter speeds to separate the fields. A shutter speed of 1/60th second made one field invisible (left picture), and showed just three lines for segments of the vertical-sync pulse and two lines with VITS. Picture at the right was made with 1/30th second shutter speed and shows perfect interlace, with 18 lines used for the hammer and four lines for VITS. Both pictures were made from the screen of a Tektronix Model 650 Video Monitor.

# "MORE MILEAGE WITH RCA"

Now you can get General Tires for auto or truck - **FREE** - with your purchase of RCA Entertainment Receiving Tubes from your participating RCA Tube Distributor.

Take your choice of any of these famous General Tire Co. Tires: Jet Air III, Dual Steel Radial, Belted Jumbo 780, and Sprint Jet. It's as easy as 1, 2, 3 . . .

1. Just see your participating RCA Tube Distributor and purchase RCA entertainment receiving tubes.
2. Get "More Mileage with RCA" certificates and accumulate the proper number for the tire(s) of your choice.
3. Redeem your certificates by mail according to instructions on certificate, for a purchase order you can take to your nearest General Tire Dealer and have your tires installed at no charge.

See your participating RCA Tube Distributor today for all the details and get "MORE MILEAGE WITH RCA." Certificates are redeemable thru September 30, 1975.



RCA/Electronic Components/Harrison, N.J. 07029



**RCA** Electronic Components

# FREE EICO CATALOG

## 346 Ways To Save On Instruments!

EICO's Test Instruments line is the industry's most comprehensive because each instrument serves a specific group of professional needs. You name the requirement—from a resistance box to a VTVM, from a signal tracer to a scope, from a tube tester to a color TV generator, etc., you can depend on EICO to give you the best professional value. Compare our latest solid state instruments at your local EICO Electronics Distributor, he knows your needs best—and serves your requirements with the best values!

**"Build-it-Yourself" and save up to 50% with our famous electronic kits.**

For latest EICO Catalog on Test Instruments, Automotive and Hobby Electronics, Eicocraft Project kits, Burglar-Fire Alarm Systems and name of nearest EICO Distributor, check reader service card or send 50¢ for fast first class mail service.

**EICO—283 Malta Street,  
Brooklyn, N.Y. 11207**

*30 years of service to the Professional Serviceman.*



46 For More Details Circle (28) on Reply Card

## test equipment report

*These features supplied by the manufacturers are listed at no-charge to them as a service to our readers. If you want factory bulletins, circle the corresponding number on the Reply Card and mail it to us.*

### Digital Multimeter

Model 41 is a 2,000 count, 4½ digit DMM with BCD output for systems applications. The product from **Data Technology** offers 5 AC and 5 DC voltage ranges, 6 resistance ranges, and 5 AC and 5 DC current ranges. The TTL compatible BCD output of reading, function, range and polarity, enables the Model 41 to be used in conjunction with printers and other digital-output devices.

For More Details Circle (50) on Reply Card

### Portable Semiconductor Tester

Pocket-sized, Model 215 semiconductor tester from **Hickok** is capable of checking NPN's, PNP's FET's, diodes, SCR's, and unijunctions.



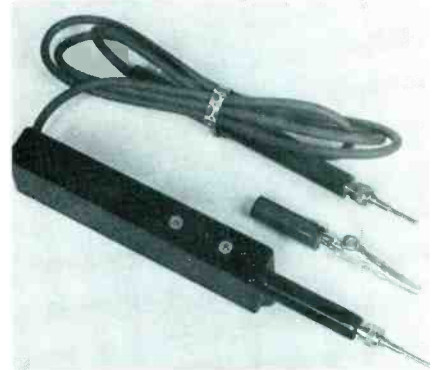
The tester reportedly determines proper lead configuration instantly and automatically, and indicates in bright LED displays if the semiconductor is good or bad. If good, the model further identifies which lead is the base, and whether it's NPN or PNP.

The tester features solid-state CMOS circuitry.

For More Details Circle (51) on Reply Card

### Four-Function Tester

Digital logic, continuity, voltage, and polarity can be checked with the Probe IV from **GC Electronics**. An



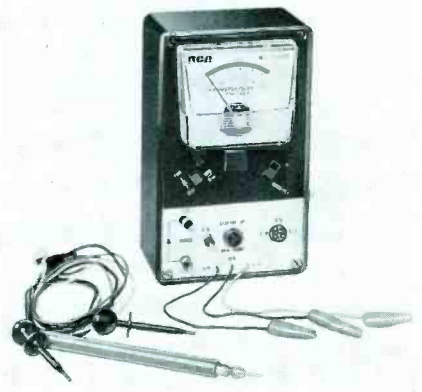
easy-to-use pocket-size tester, No. 5104 features solid-state circuitry, 3-to 600-volt AC/DC operation, and a 48-inch insulated wire lead with test probe and alligator clip adapter.

For More Details Circle (52) on Reply Card

### Portable Solid-State Checker

Fast checks for both in- and out-of-circuit devices is possible with the portable transistor/diode/FET checker from **RCA**. Model WC-506B provides 4 ways to connect the device to be tested for relative gain or leakage tests of NPN or PNP bipolar transistors, power transistors, P- and N-channel single- and dual-gate FET transistors, and relative front-to-back ratio of diodes.

A conductive foam pad on the front panel is included to discharge FET leads to minimize chance of damage due to static charge.



One extended range for all tests is possible with a special "square-law" meter. Relative gain readings are indicated on a good/bad color-coded scale.

WC-506B weighs only 14 ounces and costs \$33.00.

For More Details Circle (53) on Reply Card

### Audible Continuity Tester

ACT-1 from **Calcomp Consumer Products**, is designed to test electrical wiring and circuits without danger to delicate components. Continuity is indicated by a clearly-audible tone. The pitch varies according to the amount of resistance (0 to 50 ohms).

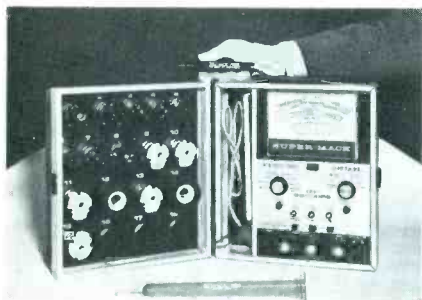
Said to be safe and reliable, the tester comes with 30-inch probes, battery and alligator clips.



Price of the product is \$12.95.  
For More Details Circle (54) on Reply Card

### Combination CRT Tester, Restorer

CR31 Super Mack is a combination CRT tester and restorer that is designed also to test operating circuit potentials. Said to be four testers in one, the product has automatic tracking tests, and is complete with 15 plug-in sockets.



Model CR31 automatically rejuvenates color tubes that need a small amount of current drawn from the cathode to obtain tracking. It also functions as a CRT restorer with timed circuits. To operate, simply push a button, and the adjustable timer restores 3 times automatically.

A manual position is provided for hard-to-rejuvenate CRT's. CR31 is a circuit-parameter tester with attached focus voltage probe up to 10KV, plus adapter to extend the range to 50KV. Line and filament voltages are measured internally to help pinpoint the cause of problems.

CR31 is priced at \$395.00 with a \$75.00 trade-in value from **Sencore**.

For More Details Circle (55) on Reply Card

### Handyman VOM

Versatile and simple-to-operate, the pocket-sized volt-ohm-milliammeter from **RCA** weighs only 5 ounces. Called the Handyman VOM, the WV-539A is designed as a general-purpose test instrument.



Meter scales are color-coded to simplify operation, and pin-jack test lead connectors help provide easy selection of functions and ranges.

The product is battery-operated, and costs \$8.95.

For More Details Circle (56) on Reply Card

(Continued on page 51)

# Polaris

## 40 KV

DUAL RANGE

# Probe

Current & Voltage Reading

For Today...  
And Tomorrow!

## \$29<sup>95</sup>

MODEL 651

RANGE NO. 1: 40,000 VOLTS DC  
RANGE NO. 2: 0-400 MA DC

Send literature and name of my distributor.

**Polaris New York**  
2862 FULTON STREET  
BROOKLYN, N.Y. 11207

Name \_\_\_\_\_  
Address \_\_\_\_\_  
City \_\_\_\_\_ State \_\_\_\_\_  
Zip \_\_\_\_\_

For More Details Circle (30) on Reply Card

## T & T VALUE SALE

RAY, I. C. C., RCA, SYL.  
FAMOUS MAKE NEW JOBBER (BOXED) TUBES

### 80% OFF LIST

<input type="checkbox"/> 3A3 .....	5 for \$5.05	<input type="checkbox"/> 6HA5 .....	5 for \$4.80
<input type="checkbox"/> 3AT2 .....	5 for \$4.90	<input type="checkbox"/> 6HV5 .....	5 for \$11.80
<input type="checkbox"/> 3GK5 .....	5 for \$4.85	<input type="checkbox"/> 6JE6 .....	5 for \$11.15
<input type="checkbox"/> 3HA5 .....	5 for \$4.80	<input type="checkbox"/> 6JS6 .....	5 for \$9.30
<input type="checkbox"/> 5GH8 .....	5 for \$5.90	<input type="checkbox"/> 6KT8 .....	5 for \$6.85
<input type="checkbox"/> 6BK4 .....	5 for \$9.35	<input type="checkbox"/> 6LB6 .....	5 for \$10.75
<input type="checkbox"/> 6CG3 .....	5 for \$4.95	<input type="checkbox"/> 6LO6 .....	5 for \$11.15
<input type="checkbox"/> 6CJ3 .....	5 for \$4.70	<input type="checkbox"/> 8F07 .....	5 for \$3.75
<input type="checkbox"/> 6DW4 .....	5 for \$4.70	<input type="checkbox"/> 12GN7 .....	5 for \$7.00
<input type="checkbox"/> 6EH7 .....	5 for \$4.80	<input type="checkbox"/> 17J28 .....	5 for \$4.50
<input type="checkbox"/> 6EJ7 .....	5 for \$4.50	<input type="checkbox"/> 23Z9 .....	5 for \$6.00
<input type="checkbox"/> 6F07 .....	5 for \$3.75	<input type="checkbox"/> 31L06 .....	5 for \$10.15
<input type="checkbox"/> 6GF7 .....	5 for \$6.65	<input type="checkbox"/> 33GV7 .....	5 for \$8.05
<input type="checkbox"/> 6GH8 .....	5 for \$3.95	<input type="checkbox"/> 36MC6 .....	5 for \$11.40
<input type="checkbox"/> 6GJ7 .....	5 for \$3.40	<input type="checkbox"/> 38HE7 .....	5 for \$9.20

• FREE—\$100.00 LIST OF CONTROLS WITH ANY PURCHASE ABOVE OF 100 TUBES.  
• A 6GH8 SPECIAL—100 for \$69 ..... 200 for \$119

### 80% & 10% OFF LIST NEW FACTORY BOXED

<input type="checkbox"/> 6BQ5 Westinghouse .....	5 for \$4.45
<input type="checkbox"/> 17BR3 Emerson .....	5 for \$3.70
<input type="checkbox"/> 35LR6 Emerson .....	5 for \$9.45
<input type="checkbox"/> 42EC4 Dumont .....	5 for \$4.73

### SYLVANIA TUBES 70% & 10% OFF LIST

<input type="checkbox"/> 3A3 .....	5 for \$6.82	<input type="checkbox"/> 6GH8 .....	5 for \$5.33
<input type="checkbox"/> 6BK4 .....	5 for \$12.62	<input type="checkbox"/> 6HA5 .....	5 for \$6.48
<input type="checkbox"/> 6CJ3 .....	5 for \$6.35	<input type="checkbox"/> 6LB6 .....	5 for \$14.51
<input type="checkbox"/> 6F07 .....	5 for \$5.06	<input type="checkbox"/> 6LO6 .....	5 for \$15.05

### TRANSISTORS XACT. REPLACEMENT (BOXED)

<input type="checkbox"/> SK3004 .....	5 for \$1.90	<input type="checkbox"/> SK3052 .....	5 for \$3.90
<input type="checkbox"/> SK3009 .....	5 for \$3.90	<input type="checkbox"/> SK3054 .....	5 for \$4.50
<input type="checkbox"/> SK3010 .....	5 for \$2.10	<input type="checkbox"/> SK3082 .....	5 for \$3.90
<input type="checkbox"/> SK3018 .....	5 for \$2.25	<input type="checkbox"/> SK3103 .....	5 for \$3.00
<input type="checkbox"/> SK3021 .....	5 for \$3.15	<input type="checkbox"/> SK3114 .....	5 for \$2.40
<input type="checkbox"/> SK3024 .....	5 for \$3.30	<input type="checkbox"/> SK3124 .....	5 for \$2.10
<input type="checkbox"/> SK3025 .....	5 for \$4.50	<input type="checkbox"/> SK3132 .....	5 for \$2.60
<input type="checkbox"/> SK3040 .....	5 for \$3.75	<input type="checkbox"/> ECC155 .....	5 for \$4.90
<input type="checkbox"/> SK3041 .....	5 for \$4.20	<input type="checkbox"/> ECG131 .....	5 for \$3.90
<input type="checkbox"/> SK3042 .....	5 for \$6.60	<input type="checkbox"/> HEP707 .....	5 for \$15.00

### DIODES & RECTIFIERS

RCA Damper Diode Equip. to:	
<input type="checkbox"/> RCA 120818 .....	\$1.95—RCA 135932 ..... \$2.95
<input type="checkbox"/> ITT 6500 PIV Color Focus Rect. ....	10 for \$5.00
<input type="checkbox"/> 2.5 amp 1000 PIV IR170 .....	<input type="checkbox"/> 100 for \$11.00
	<input type="checkbox"/> 20 for \$3.50

### YOKES & TUNERS

<input type="checkbox"/> TUNER inc. 6GS7, 6HA5 .....	\$2.95
<input type="checkbox"/> Combo TUNERS inc. tubes .....	\$4.95
<input type="checkbox"/> Y105—Y94—Y130 95-2874 .....	\$6.95
<input type="checkbox"/> Zen. Color Yoke 95-2532 repl. ....	\$11.95
<input type="checkbox"/> RCA Color Yoke 906214-501 .....	\$8.95
<input type="checkbox"/> Syl. E01 51-29978-1 Color Yoke .....	2 for \$15.00
<input type="checkbox"/> Emerson 825 incl. 6CG8, 3GK5 .....	\$5.95
<input type="checkbox"/> Emerson 711 incl. 6GX7, 6HQ5 .....	\$6.95

### RCA—ZENITH MODULES

<input type="checkbox"/> 132579—133455—134400 .....	ea. \$3.49
<input type="checkbox"/> 9-50—9-59—9-79 .....	ea. \$3.95

### AUDIO

<input type="checkbox"/> 60 Min. Cassette Irish .....	6 for \$2.50
<input type="checkbox"/> 84 Min. 8-Track Irish Tape .....	3 for \$3.00
<input type="checkbox"/> Equiv. Shure N44, N75, N77, N91 .....	ea. \$2.95
<input type="checkbox"/> Equiv. Pickering V15 .....	ea. \$2.95
<input type="checkbox"/> BSR Cartridges—SX5M, SX1H, SC5M .....	3 for \$5.00
<input type="checkbox"/> ASTATIC 735 Cartridge .....	\$3.95
<input type="checkbox"/> Remote Mikes Min. Plug .....	4 for \$6.00
<input type="checkbox"/> Stereo Head Sets .....	ea. \$4.95—2 for \$7.95
<input type="checkbox"/> Stereo Dual Mikes Ampex .....	\$5.95
<input type="checkbox"/> Speaker Kit—2-4", 2-5", 2-4x6, 4-6" .....	10 for \$12.00

### ANTENNA SUPPLIES

<input type="checkbox"/> J.F.D. CO-14 4 Set Coupler .....	10 for \$10.00
<input type="checkbox"/> 2 Set 72 ohm Coupler .....	\$2.95
<input type="checkbox"/> 4 Set 72 ohm Coupler .....	\$3.95
<input type="checkbox"/> 72 ohm UHF VHF Signal Splitter .....	5 for \$7.50
<input type="checkbox"/> 59U F Connectors .....	100 for \$10.00
<input type="checkbox"/> JFD DCM101 All Channel Color Antenna .....	ea. \$9.95

### GENERAL

<input type="checkbox"/> 19 & 25"—21" Color Boosters .....	3 for \$11.95
<input type="checkbox"/> Zen. VOLTAGE TRIPLER, 212-136 .....	3 for \$12.00
<input type="checkbox"/> Blue Lateral Magnets with P.R. .....	10 for \$10.00
<input type="checkbox"/> Jap Phono arm incl. cartridge .....	10 for \$5.00

Minimum Orders—\$50.00 F.O.B. Brooklyn, N.Y.  
Catalog \$1.—Refundable Upon Your Order.  
C. O. D. CASH ONLY.

## T & T SALES CO.

**4802 AVENUE K**  
**BROOKLYN, N. Y. 11234**  
Phone: (212) 241-5940

For More Details Circle (22) on Reply Card 47

# Measure 100 $\mu$ V to 40 kV ...for less than \$200!

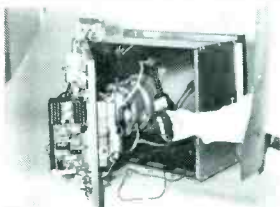
Now it's possible to get just about all the voltage measurement capability you'll ever need. With these new instruments from Heath — The IM-2202 Portable Digital Multimeter and the IM-5210 High Voltage Probe Meter — you can have DC voltage measurement capability over a 166 dB dynamic range, for a total cost of only \$197.90\* for both instruments.



The lowest priced professional-grade DMM we've ever offered...

only  
**\$179.95\***

Designed for field or bench, the portable IM-2202 will provide years of dependable measurement for the professional serviceman. Four rechargeable nickel-cadmium batteries (included) provide up to eight hours of continuous operation. Or it may be operated from 110/220 VAC when continuous operation is necessary. Full scale ranges are 100 mV (with 100  $\mu$ V resolution!) to 1000 volts DC, 100 mV to 750 volts AC, 100  $\mu$ A to 1000 mA and 100 ohms to 1000 kilohms. The 100% overrange allows measurement to 1.999 on all ranges except 1000 VDC and 750 VAC, giving full 2 amp or 2 megohm capability. All voltage ranges have high input impedance to prevent circuit loading. Internal standards allow calibration to 0.5% for DC and 1% for AC or, with a lab standard, 0.2% for DC and 0.5% for AC. Readout is a large, 3 1/2-digit display with automatic polarity indication and decimal point placement. Operation couldn't be simpler — a Range switch and four pushbutton Function switches select any of the measurement ranges. Easy operation, high accuracy and dependable performance...you get them all with the Heathkit IM-2202. Available in kit-form only, \$179.95\*.



New Heathkit probe meter measures TV tube voltages to 40 kV...

only **\$179.95\***

TV tube voltage measurements are fast and easy with the IM-5210 Probe Meter. You just attach the ground clip to the TV chassis, place the probe tip against the tube's high voltage connector and switch on the meter. It's an easy kit to build, taking about an hour to assemble. With a kit-form price of \$17.95\*, it's just about the best high voltage measurement value on the market. Also available assembled, only \$24.95\*.



**Send for your free Heath catalogs**

The latest Heath/Schlumberger Assembled Instruments Catalog features a complete line of high performance, low cost instruments for service and design applications. Our '75 Heathkit Catalog describes the world's largest selection of electronic kits — including a full line of lab and service instruments. Send for your free copies today.

HEATH COMPANY  
Dept. 25-02  
Benton Harbor, Michigan 49022

HEATH  
Schlumberger

- Please send the 1975 Heathkit Catalog.  
 Please send the latest Heath/Schlumberger Assembled Instruments Catalog.

Name \_\_\_\_\_

Title \_\_\_\_\_

Company/Institution \_\_\_\_\_

Street \_\_\_\_\_

City \_\_\_\_\_ State \_\_\_\_\_ Zip \_\_\_\_\_

\* MAIL ORDER PRICES; F.O.B. FACTORY.

PRICES & SPECIFICATIONS SUBJECT TO CHANGE WITHOUT NOTICE

TE-315

For More Details Circle (14) on Reply Card

## bookreview

### Practical Solid-State Circuit Design

Author: Jerome E. Oleksy

Publisher: Howard W. Sams & Co., Inc. 4300 West 62nd Street, Indianapolis, Indiana 46268

Size: 5 1/2 X 8 1/2 inches, 191 pages, catalog number 21018

Price: \$5.95 softbound

Emphasizing the experimental method of learning, Oleksy begins with a discussion of power supplies, and proceeds with instructions for designing transistor amplifiers, FET and op-amp circuits, audio power amplifiers, and regulator circuits. Throughout the text are short examples and quiz questions to help the reader gauge his understanding of the material. Before reading, you need to have some knowledge of Ohm's law for AC and DC circuits plus an understanding of simple test equipment. This book is for the technician who is interested in constructing "tailor-made" circuits for a variety of applications. Many formulas and tables valuable to the experimenter are included.

**Contents:** Power Supplies; Transistor Amplifier Design; Field Effect Transistors; Differential and Operational Amplifiers; Using Integrated Circuit Op Amps; Oscillators and Waveform Generators; Audio Power Amplifiers; and Regulated Power Supplies.

### Electronics Unraveled—A New Commonsense Approach

Author: James Kyle

Publisher: TAB Books, Blue Ridge Summit, Pennsylvania 17214

Size: 228 pages, 96 illustrations, book number 691.

Price: \$7.95 hardbound, \$4.95 paperback

Departing from the traditional teaching approach, this book begins its active-element discussion with a detailed description of the simple relay. This concept is applied and compared with the operation of transistors, vacuum tubes, and other active devices. Using a conversational approach, Kyle mixes theory with the history of electronics for reader interest. The author covers the basics as well as such advanced concepts as duality in electronics in a simple but comprehensive manner. Reader experimentation is encouraged, and a variety of circuits are included for quick, easy construction.

**Contents:** From Electron to Einstein; Energy Sources; Passive Circuit Elements; Simple Circuits; Active Circuit Elements; Useful Circuits; Learn By Doing.



(Continued from page 47)

### Multi-Use Battery Tester

A battery-tester that checks most popular battery types under typical load conditions, plus fuses, switches, light bulbs and complete flashlight systems, has been announced by RCA Electronic Instruments.



Priced at \$18.75 with test leads, the tester's large color-coded meter scale is specially marked to indicate levels at which rechargeable batteries should be recharged. Also, a separate

color-coded scale is provided for testing mercury batteries.

A special feature of the WT-537A is the "bulb test" which is actually a continuity tester.

For More Details Circle (57) on Reply Card

### Low-Cost Frequency Counter

Systron-Donner has introduced Model 6202A, a 20-Hz to 5-MHz counter. Rugged and small, the counter is said to be easy-to-operate. An auto-ranging pushbutton programs the counter to fill the display register, while it automatically selects maximum frequency resolution.

Also, the 6202A has manually-adjustable input controls for setting trigger levels, and signal attenuation to screen out the effects of noise superimposed on the input signal.



The unit is priced at \$435.00.

For More Details Circle (58) on Reply Card

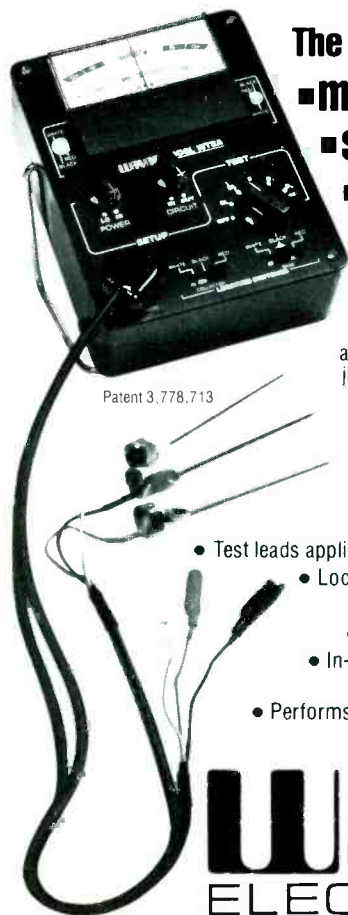
### Versatile Digital Multimeter

Peck/Boss has introduced a digital multimeter and frequency counter which features a 4-1/2 digit Sperry planar display and 44 ranges. Model 390 measures capacitance in 7 ranges from 1 nanofarad fullscale to 100 microfarads F.S. The unit is overload-protected by a fuse system and features 10,000 megohm input impedance at 10 volts D.C. Eight resistance scales, with accuracy from .02 percent, register from .1 ohms F.S. to 1000 megohms.



Model 390 sells for \$368.00, and it is available without the AC voltage and AC current ranges, for \$329.00.

For More Details Circle (59) on Reply Card



Patent 3,778,713

### The Wayne Model WT2A

- makes YOU money
- saves much time
- makes trouble-shooting easier

A new concept in transistor testing based on proven methods of circuit analysis. A current limited AC voltage is applied to each semiconductor junction under test. The resulting DC voltage is monitored while the rectifying junction is passing normal rated current. Abnormalities are easily identified.

- Indicates PNP or NPN
- Measures relative gain
- Test leads applied without prior basing knowledge
- Locates base and collector during test
  - Indicates silicon or germanium
  - Indicates transistor non-linearity
- In-circuit tests with shunt impedance down to THREE ohms
- Performs all of above and more in less than ten seconds

**WAYNE**  
ELECTRONICS  
5412 Nordling St. / Houston, Texas 77022

For More Details Circle (20) on Reply Card

February, 1975

**SOLDERING +  
DESOLDERING +  
RESOLDERING =  
SOLDER ABILITY**

ELEMENTARY TO ELITE  
WORLD'S MOST PRACTICAL SOLDER HANDLING TOOLS

*meets industries demands....*

with a COMPLETELY PORTABLE SOLDERING/DESOLDERING/RESOLDERING SYSTEM

**NEW FANOVISION**  
WORLD PREMIER  
144 Page Manual  
**SolderABILITY TECHNIQUES**

**EDSYN**  
15958 ARMINTA STREET  
VAN NUYS, CALIFORNIA 91406  
PHONE (213) 989-2324  
TELEX NO. 65-1469 EDSYNEX VAN

**3-KODIAK**

\* NOTE: FANOVISION Manual will be sent FREE with purchase of \$7.95 (or more) of any EDSYN Products. Limit one FREE MANUAL to a customer.

For More Details Circle (13) on Reply Card

# audio systems report

These features supplied by the manufacturers are listed at no-charge to them as a service to our readers. If you want factory bulletins, circle the corresponding number on the Reply Card and mail it to us.

## Compact Speaker System

P-5 is a cube-shaped speaker with a tough polyurethane finish. Manufactured by **Sound West**, the compact model is priced at \$12.95 and is avail-



able in several colors. Each speaker features a 4-inch high-compliance speaker and RCA-type plugs or screw-terminals.

For More Details Circle (60) on Reply Card

## Glass-Cone Speakers

Designed for 4-channel as well as 2-channel sound, the Shot Glass speaker system from **White Electronics** features unique glass-cone speakers. Its performance reportedly



unaffected by weather changes, the unit is said to eliminate distortion produced by cone flutter. The \$159.50 system includes four 5-inch Glasscone woofers with 12-ounce ceramic magnets, one 3 1/2-inch tweeter, and a

1000-Hz crossover network. Maximum power rating is 70 watts RMS per system.

For More Details Circle (61) on Reply Card

## Siren Speaker Driver

**Atlas Sound** introduces Model SD-370 weatherproof siren-speaker driver for electronic-siren, signaling, and public-address systems. Loudspeakers



equipped with the driver can produce a sound pressure level of 100 dB at a distance of 100 feet.

For More Details Circle (62) on Reply Card

## Cut out this coupon and you may cut out a new career as a two-way radio technician.

Take advantage of the growth in electronic communications. Become a two-way radio technician. The need for qualified people has never been greater and opportunities are nationwide. Thousands have increased their knowledge of two-way radio through the 40-Lesson MTI home-study course.

Simply fill in this coupon and mail it to us. We'll send you information on how you can learn more about this specialized field, at home, for only \$275.

I am interested in cutting out a new career as a two-way radio technician. Please send full details of the MTI course.

Name \_\_\_\_\_

Address \_\_\_\_\_

City/State/Zip \_\_\_\_\_

I am a veteran or serviceman



**MOTOROLA TRAINING INSTITUTE**  
108 College Hill Road, Summerdale, Pennsylvania 17093

For More Details Circle (15) on Reply Card

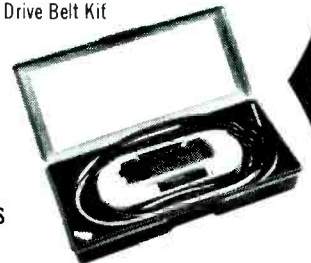
## WANT COMPLETE INFORMATION ON **Oneida** DRIVE BELTS & "O" RINGS

Three Kits do it all! Your kits eliminate need for stocking large replacement inventory. This is all you need to make easy repairs on . . . 8 tracks, cassettes (both imports and domestic) whether drive belt is round, flat or square. Kits come complete with ample rubber stock, Instant-Weld Adhesive, jig for controlling cuts, razor blade and special cleaning compound.

- ORK-1 Round Rubber Drive Belt Kit
- ORK-2 Flat & Square Rubber Drive Belt Kit
- ORK-3 "O" Ring Kit

No "down time" . . . no specials . . . no molds . . . no vulcanizing.

**PRODUCE INSTANT  
DRIVE BELTS & "O" RINGS**



Send literature with details and name of nearest Distributor.

Name \_\_\_\_\_

Company \_\_\_\_\_

Address \_\_\_\_\_

City \_\_\_\_\_ State \_\_\_\_\_ Zip \_\_\_\_\_

**ONEIDA ELECTRONIC MFG., INC.**

P. O. BOX 678 NORTH COTTAGE STREET  
MEADVILLE, PA. 16335  
PHONE 814/336-2125

For More Details Circle (16) on Reply Card

ELECTRONIC SERVICING

PHOTOFACT BULLETIN lists new PHOTOFACT coverage issued during the last month for new TV chassis.

<b>ADMIRAL</b>	
Chassis T1K6-1B/-2B, T2K6-1B/-2B .....	1447-1
<b>CATALINA</b>	
122-5349A, 122-5388A .....	1446-1
<b>CORONADO</b>	
TV24-1035A .....	1445-1
<b>HITACHI</b>	
S-97 (Ch. SVS) .....	1445-2
<b>JC PENNEY</b>	
2344A (855-2143) .....	1456-1
2831 (855-2341) .....	1461-1
<b>MOTOROLA</b>	
Chassis LTS-938F .....	1456-2
<b>PANASONIC</b>	
CT-2514, CT-2524, CT-2534 (Ch. ETA-82) .....	1459-1
<b>RCA</b>	
Chassis KCS187C .....	1457-2
<b>SEARS</b>	
528.41950300 thru 528.41950327, 528.41951400 .....	1461-2
<b>SHARP</b>	
C-1934 .....	1458-2
<b>SONY</b>	
KV-5000 (Ch. SCC-37A-A/A-B) .....	1457-3
TV-520 .....	1461-3
<b>TOSHIBA</b>	
C335, C335C .....	1456-3
<b>TRUETONE</b>	
WEG2587A-57(2DC2587), WEG2589A-57(2DC2589) .....	1459-3
<b>SYLVANIA</b>	
Chassis A12-3/-4/-5, A16-2/-3 .....	1459-2
<b>ZENITH</b>	
Chassis 16EB12X, 16EB12ZX (1975 Prod.) .....	1458-3

**Your comments and ideas are welcome.**

Address your letters to:

Carl Babcoke, Editor Electronic Servicing  
1014 Wyandotte Street Kansas City, Missouri  
64105

# DO-IT-YOURSELF grabber



Model 3925  
Mini Test Clip  
Shown Actual Size

- Simplified Assembly
- Versatile
- Comfortable Finger Grip Action
- Completely Field Serviceable
- Molded of Tough Lexan\*

This test clip with gold plated hook is excellent for rapid testing of components and Wire Wrap† pins. Clip is completely insulated to point of connection. Build any combination of test leads with wire up to .090 dia. Easy and comfortable to operate. Molded of rugged Lexan to resist melting when soldering. Write for literature and prices.

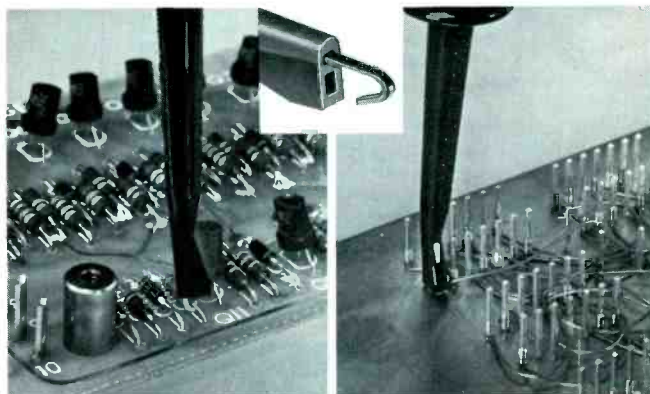
## SIMPLIFIED ASSEMBLY



Rapid assembly or replacement  
of damaged lead.

## MODEL 3925

hooks onto components or slips over square Wire-Wrap pins



\*Lexan is a General Electric trade-mark. †Registered trade-mark of Gardner-Denver Co.

AVAILABLE ONLY THROUGH ELECTRONIC PARTS DISTRIBUTORS



**POMONA ELECTRONICS**

A Division of ITT

1500 East Ninth St., Pomona, Calif. 91766

For More Details Circle (25) on Reply Card

# catalogs literature

Circle appropriate  
number on Reader  
Service Card.

**100. Littelfuse**—the line of "Littelite" miniature lampholders is featured in a color catalog that includes detailed drawings complete with mounting dimensions, information tables, and a cross reference to military part numbers. An easy-to-use ordering table lists available options, special features, housing finishes, resistors, lens-cap styles, and colors.

**101. Altec**—a 24-page color illustrated brochure features the Altec line of hi-fi loudspeaker systems, including raw-frame speakers and utility systems.

**102. Pageant/M. A. Miller Industries**—offers a 1974 catalog on

Pageant-brand replacement needles. Illustrations and descriptions of more than 800 styles of needles in both sapphire and diamond types are included. The catalog makes it possible to locate a particular needle style by knowing either the cartridge number, phonograph model number, or the needle number of another manufacturer.

**103. Triplett**—a 16-page catalog features Triplett's line of test equipment, from multi-purpose VOM's through laboratory and special features-testers, to G/P portables, temperature testers and accessories. The catalog, 60-T, contains a selection guide chart designed to help select a tester for specific requirements.

**104. GTE Sylvania**—the catalog features 45 pages of information on Pathmaker wideband communications equipment. Included are sections on Series 2000 and 1000 trunk-amplifier stations, plug-in modules, power supplies, passives, and accessories. Product specifications and ordering information are given.


**105. Marconi Instruments**—the short-form catalog includes: FM/AM signal generators, FM deviation meters, HF spectrum analyzers, mobile-radio test gear, TV test equipment, intermodulation and baseband test gear, microwave instrumentation, bridges, Q-meters, and PCM/digital test equipment.

**106. International Rectifier**—the new edition of commercial products, lists four new product lines: Japanese "original equipment" transistors (for use in replacing Japanese TV and audio equipment parts); high-turnover electrolytic capacitors with working voltages from 12 to 50 volts; four matched-pair transistors to expand replacement capability; and lighted rocker switches in SPDT and DPDT versions. Also listed are various types of rectifiers, semi-conductors, and diodes, as well as color TV components. The brochure gives complete specifications, line drawings, photographs, and prices. □

For news of our industry,  
read *Electronic Scanner*,  
page 4

BRAND NEW FROM ENDECO

## the soldering iron with a light



Exclusive new safety light  
shows when power is on  
MODEL 540S \$10.95 NET

Two heats—20w and 40w—to handle any job  
• On-off switch • Cool, unbreakable polycarbonate handle • Ironclad tips for longer life  
• Burn-resistant neoprene cord • 8½" long, 2 oz • Converts to a desoldering iron with low cost attachment • Also desoldering irons and soldering/desoldering kits.

To locate your nearest distributor  
call toll-free 800-645-9200




5127 EAST 65TH ST.  
INDIANAPOLIS,  
INDIANA 46220  
PHONE 317/251-1231

enterprise  
development  
corporation

For More Details Circle (18) on Reply Card

# ACA



TV and FM ANTENNAS  
AND ELECTRONICS

ANTENNAS  
FIELD-ENGINEERED  
and TESTED  
in your area  
FOR YOUR AREA

Call or write: P.O. Box 865, Burlington, IA 52601  
Phone: 319-753-1625

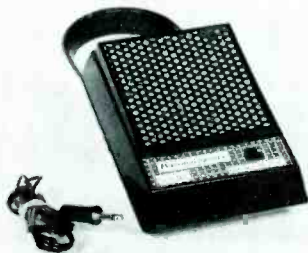
For More Details Circle (19) on Reply Card

# productreport

These features supplied by the manufacturers are listed at no-charge to them as a service to our readers. If you want factory bulletins, circle the corresponding number on the Reply Card and mail it to us.

## Personal Security Alarm

Personal-Sentry alarm, catalog number 30-9005 by **GC Electronics**,



easily attaches to any door for protection against burglars or intruders. If you travel, the unit can be removed and taken to the next hotel or motel. The dual-purpose alarm is small and lightweight, and operates on two AA-size batteries.

For More Details Circle (64) on Reply Card

## Solderless Terminal Kits

Six solderless terminal kits from **Waldom Electronics** include 12 popular types of terminals for wire sizes ranging from 22-18 through 12-10. Each kit has a universal crimping tool with built-in bolt cutter and wire stripper.

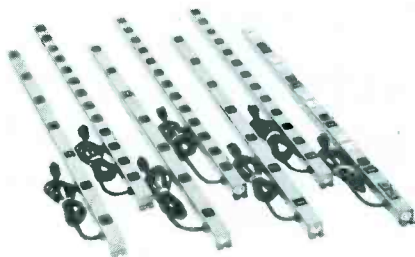


All Waldom insulated terminals offer beveled mouths for ease of wire insertion, multiple "V" grooves for maximum holding power and minimum contact resistance, open-barrel construction, strength gussets, and uniform electro-tin plating. All are made from pure electrolytic copper, annealed for crimping ease, and the wire range is stamped on back.

For More Details Circle (65) on Reply Card

## Power Outlet Strips

A new series of outlet strips in longer sizes has been introduced by **SGL Waber Electric**. Model 1100 series is 1-1/2 inches wide by 1-1/8 inches deep, and is available in either 4- or 6-foot lengths.



The strips come in switched or unswitched types, and with fuse or circuit-breaker protection.

All strips are rated at 130V/15A, the sockets have "U" grounds, and the case is made of steel.

For More Details Circle (66) on Reply Card

## Communications Organizer

A new concept in mounting vehicular communications equipment, the **Acme Communications Organizer (ACO)** places all required equipment at the fingertips of the operator.

ACO mounts on the floor of the vehicle, and brackets can be added or taken away to accommodate a 2-way radio receiver, radio speaker/amplifier, siren, or radar receiver.

The ACO pivots right or left for easy access, is easy to install, and is interchangeable between vehicles.

For More Details Circle (67) on Reply Card

## Twist-Lok Adapters

It's now possible with PC-8 adapters to mount **Sprague TVL** twist-lok electrolytic capacitors on printed wiring boards, as replacements for OEM types having special terminals.

Easily secured for permanent installation, the **Sprague** adapters come in a package of eight with complete installation instructions.

For More Details Circle (68) on Reply Card

## Anglo-Metric Converter

Adjusting to the Metric system is made easier with a handheld **Anglo-Metric** converter from **Telex Communications**. Information equivalent to a full-sized slide rule is available by dialing the desired conversion. Compact, fast, and accurate, the converter is constructed of heavy-duty plastic and laminated to prevent wear. □

For More Details Circle (69) on Reply Card

## TeleMatic

MJ-195

# MASTER TEST RIG

## FOR TUBE AND SOLID STATE SERVICING

\$149.95

less 19" picture tube

- 30 KV CAPACITY
- METAL CABINET
- SPEAKER BUILT IN

- HIGH VOLTAGE METER
- STATIC CONVERGENCE
- FRONT PANEL CONNECTIONS

## TeleMatic

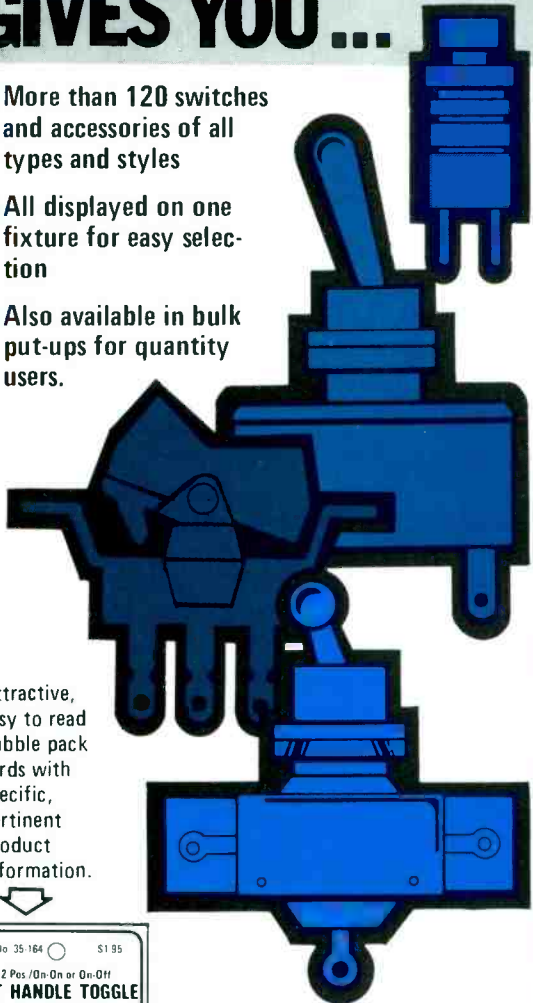
2245 Pitkin Ave., Brooklyn, N.Y. 11207

FREE! Adaptor Quick Reference Chart

For More Details Circle (29) on Reply Card

# BEFORE YOU BUY A SWITCH... CONSIDER THIS— ELECTROGRAFT GIVES YOU ...

- More than 120 switches and accessories of all types and styles
- All displayed on one fixture for easy selection
- Also available in bulk put-ups for quantity users.



Attractive, easy to read bubble pack cards with specific, pertinent product information.



48 page catalog complete with technical specs, templates and cross reference also available



**GC ELECTRONICS**  
DIVISION OF HYDROMETALS, INC.  
ROCKFORD, ILLINOIS 61101 U.S.A.



## reader's exchange

**Needed:** Schematic and calibration instructions for Waterman S-11-A oscilloscope and IBM Model 200C VOM.

Norman Quarles  
6840 S.W. 94th Street  
Miami, Florida 33156

**Needed:** Wollensak Model T1500 tape recorder. Can be new or in good condition. Will pay cash; give details and price.

J. J. Yowns  
4578 Ashbaugh Road  
Murrysville, Pennsylvania 15668

**Needed:** Old Atwater Kent or Crosley radios. Please send information.

Tom's TV Service  
714 Poplar Street  
Erie, Pennsylvania 16502

**Wanted:** Quietrole lubricant dispenser (looks like a plunger and pressure fitting.)

S. A. Elosh, Jr.  
231 Gladstone  
Campbell, Ohio 44405

### FOR TIGHT SPOTS!

18°  
Working  
Arc

CATALOG  
AVAILABLE

## CHAPMAN

### Midget RATCHET SETS plus ADAPTERS

Designed to function in confined space, Chapman Tools are a must for anyone who deals with small to medium size screws, bolts and nuts. Economy priced sets are available in a wide range of assortments covering Allen Hex, Metric Hex, Slotted, Phillips, Bristol and Reed and Prince sizes. Ratchet requires only 18° work ark. Screwdriver Handle and Extension included.

POCKET SIZED  
ECONOMY PRICED KITS

**KIT No. 6320 only \$13.60**

**Write! . . . THE CHAPMAN MANUFACTURING COMPANY**  
DURHAM, CONNECTICUT 06422 Dept. ES-2

For More Details Circle (17) on Reply Card

ELECTRONIC SERVICING

**Needed:** Complete manual or copy for Heathkit variable power supply Model PS-3. Will pay for cost.

G. A. Tyler  
2317 W. 243 Street  
Lomita, California 90717

**Needed:** Service data for a Sico Model 77 VTVM.

J. D.'s TV  
Box 105  
Noel, Missouri 64854

**Wanted:** Schematic and parts list for Model LT-500 Telesound transistor amplifier.

Stanley J. Pepera  
717 Gratiot  
Saginaw, Michigan 48602

**For Sale:** Sencore FS 134 field-strength meter in good working order. Will accept highest offer.

Jerry Jackson  
924 Main Street  
Paris, Kentucky 40361

**Needed:** CRT 5CP1 instruction manual for Precision E-200-C signal generator, and latest available roll chart for a Hickok Model 800 tube checker.

A. O. Orjias  
5817 Tyler Street  
Hollywood, Florida 33021

**Needed:** Service data and special tape cartridges for a Dormiphone Memory Trainer, a combination tape recorder and clock. The model number seems to be A-4.

Don Higgins  
P.O. Box 1182  
Russelville, Arkansas 72801

**For Sale:** B&K test equipment, Telematic test jig, and others; very good condition. Send for list and prices.

Joe Andrews  
3313 Killarney Road  
El Paso, Texas 79925

**Needed:** Two 12EQ7 tubes.

V. J. Flateau  
319 P. C. Sweet Road  
Kelso, Washington 98626

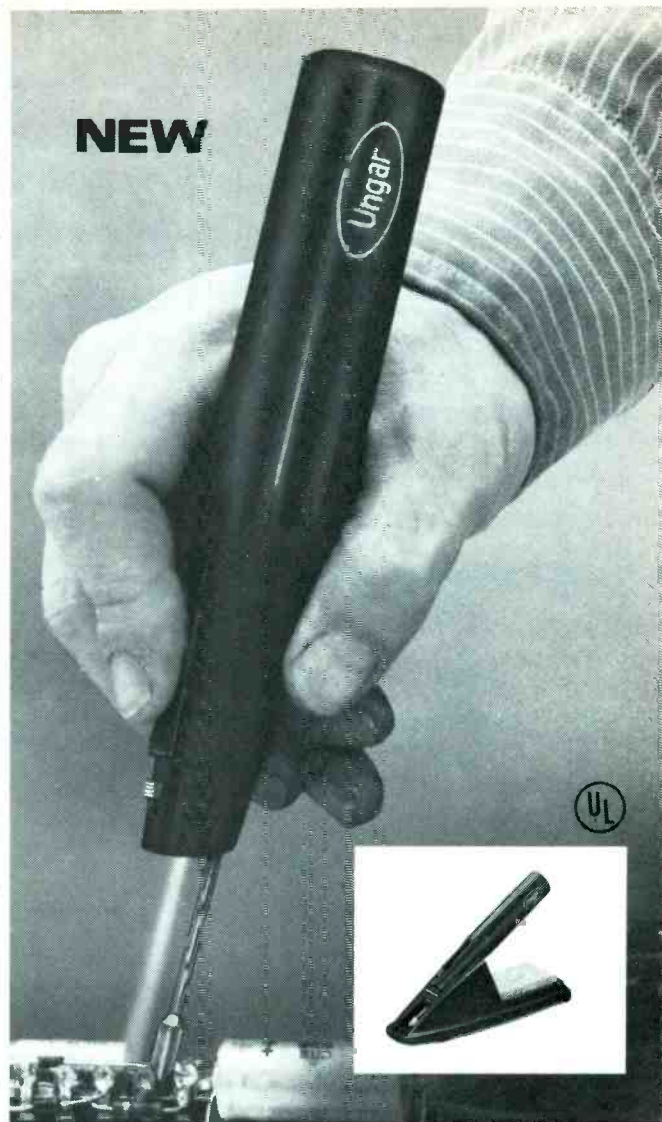
**Needed:** Schematic and operating manual for TEK model MPN3H22 VHF-FM mobile/portable transceiver; also name and address of manufacturer. Require modules 7 and 16.

William A. Johnson  
158 Newark Lane  
Hoffman Estates, Illinois 60172

**Needed:** Tube characteristics and socket diagram for an EL-12 tube. It is in a German organ amplifier.

Donald D. Tribble  
6449 Perrin Way  
Carmichael, California 95608

**Ideas for articles?  
Send them to ES, now!**



## NEW

### Ungar's Rechargeable Soldering Station #194

Cordless . . . nickel cadmium battery powered iron allows the operator unrestricted freedom for hard-to-reach assemblies and breadboard prototype work. Perfect for radio, TV and other electronic equipment service and repair, in the field or at the bench. Ideal too for electronic kit assembly.

- Lightweight iron is held like a pencil.
- Convenient, easy touch operating trigger control, with "power-on" indicator light and interlock "off" switch.
- Melts solder in seconds with Ungar's exclusive rigid coaxial element tips. Long enough to reach tuner.
- Tunnel light floods work area.
- Iron stores and recharges in unique holder with built-in sponge tray for efficient tip cleaning and care.

DESIGNED FOR PROFESSIONALS BY PROFESSIONALS  
Call your Ungar Distributor today



UNGAR, DIVISION OF ELCON INDUSTRIES, INC.

## FREE ALARM CATALOG

Full line of professional burglar and fire alarm systems and supplies. 96 pages, 450 items. Off the shelf delivery, quantity prices.



mountain west alarm  
4215 n. 16th st., phoenix, az. 85016

For More Details Circle (23) on Reply Card

## APPLIANCE REPAIR BOOKS

Written in easy-to-understand language by experts with illustrations & diagrams. Acclaimed by instructors & professionals. How to diagnose & repair air conditioners, refrigerators, vacuum cleaners, ranges, washers, dryers, steam irons, portable kitchen appliances, water heaters, plus how to set up a shop, using test instruments and more. Only \$2.65 to \$4.90 each!

SEND FOR FREE DESCRIPTIVE PRICE LIST

C & N, DEPT. ES, 5841 MONTROSE, CHICAGO 60634

For More Details Circle (24) on Reply Card



"You'll find a copy of How to Repair Your Color TV Yourself in the Fiction department."



"This is my first solo job, lady. Where's the TV you want me to practice on?"

## The MARKETPLACE

This classified section is available to electronic technicians and owners or managers of service shops who have for sale surplus supplies and equipment or who are seeking employment or recruiting employees.

### Advertising Rates

in the Classified

Section are:

- 25 cents per word (minimum \$3.00)

- "Blind" ads \$2.00 additional

- All letters capitalized 35 cents per word

Each ad insertion must be accompanied by a check for the full cost of the ad.

Deadline for acceptance is 30 days prior to the date of the issue in which the ad is to be published.

This classified section is not open to the regular paid product advertising of manufacturers.

## FOR SALE

**INCREASE EARNINGS**—YOU deserve more for your expert electronics know-how. Service Contract Cookbook, and, Practical Home Electronics Business Manual tell how. Either book, \$15.00. Both ordered at same time, \$25.00. Prepaid. NATESA SCOPE, 5908 S. Troy St., Chicago, Ill. 60629. 12-74-3t

**TV & RADIO TUBES** 36c EA!! Free color catalog. Cornell, 4221 University, San Diego, California 92105. 10-74-6t

**NEW Canadian Magazine** "Electronics Workshop". \$5.00 yearly. Sample \$1.00. Ethko, Box 741, Montreal "A" Canada. 10-74-12t

**UNUSUAL SURPLUS AND PARTS Catalog.** \$1. ETCO Electronics Dept. E.S., Box 741, Montreal "A" H3C 2V2. 12-74-12t

**PRECISION E200 and E400 signal and sweep generators,** includes cables. Best offer. Also many **OBSOLETE TUBES.** \$4.00 each shipped. List your needs. Elmwood TV, 136 Market Square, Newington, Conn. 06111. 1-75-2t

**DYNCO-A-R-TRANSISTORS, REPAIR BOARDS & UNITS, SPEAKER SERVICE. SEND FOR PRICES AND DETAILS:** BEAR ELECTRONICS, 177-E-HILLCREST ROAD, MT. VERNON, N.Y. 10552. 1-75-3t

**T.V. SERVICEMEN:** 2.5A-1000V diodes; Hep-170, IR-170 4/\$1.00. Fantastic prices; test equipment, parts. 10 cents for list. F. & M. Electronic Dist. Box 236, DEPT. K Maspeth, N.Y. 11378. 1-75-4t

**TELEVISION BUSINESS:** Grossing over \$35,000. Complete workshop, showroom 30 x 60 bldg. - floor planned - have contracts - town of 5000 growing. Value \$27,000. Take \$19,000. Room to grow for one with capital and desire. Write Box 559, Ballinger, Tex. c/o H. C. McCoy. 2-75-1t

## FOR SALE (CONT'D)

**INSTRUCTION MANUALS** - Thousands available for test equipment, military electronics. Send \$1.00 (refundable first order) for listing. A service of Tucker Electronics, Box 1050, Garland, Texas 75040. 2-75-1t

**CONSTRUCTION PLANS.** Why pay hundreds of \$\$\$ for equipment when you can build from junk box? Save with construction plans by TIPS. TUNER SUBBER, 12 VOLT POWER SUPPLY SOLID STATE PART TESTER, CB ANTENNA, COLOR CRT ADAPTOR FOR B/W TESTER, FIX YOUR OWN TV, INSTANT-ON TV ADAPTOR, MANY WAYS TO USE OHMMETER. \$1.00 each. 7 for \$5.00. TIPS, Box 188, Bruce, Mississippi 38915. 2-75-2t

**B. & K. ANALYST model 1077B** near new used less than 10 hours, complete in original box. \$300.00. Call 501-273-5340 or write Charles Rakes, Box 445, Bentonville, Arkansas 72712. 2-75-1t

## EDUCATION-INSTRUCTION

**REPAIR TV TUNERS**—High Earnings; Complete Course Details, 12 Repair Tricks, Many Plans, Two Lessons, all for \$2. Refundable. Frank Bocek, Box 3236 Enterprise, Redding, Calif. 96001. 12-74-6t

## HELP WANTED

**JOB OPPORTUNITY** for Qualified Color T.V. serviceman. Send resume to MILLER'S RADIO SHACK, 801 Texas, Goodland, Kansas 67735. 2-75-2t

## advertisers' index

Antenna Corp. of America	54
B&K Div., Dynascan Corp.	27
Bussman Mfg. Div., McGraw-Edison	33
Castle TV Tuner Service	Cover 4
Chapman Manufacturing	56
Charous and Niebergall, Inc.	58
Edsyn, Inc.	51
Eico Electronic Instrument Co.	46
Enterprise Development Corp.	54
Fluke Manufacturing Co.	18
G C Electronics	56
General Electric Company, Receiving Tube Dept.	22
Hearth Company	48
Hickok Electrical Instr. Co.	17
Mallory Distributor Prod.	3
Motorola Training Institute	52
Mountain West Alarm Supply Co.	58
Oneida Electronic Mfg., Inc.	52
Pomona Electronics	53
Precision Tuner Service	Cover 2
RCA Electronic Components	45
Howard W. Sams-Photofact	1
Sperry Tech, Inc.	10
Sprague Products Co.	9
T & T Sales Company	47
Tektronix, Inc.	37
Telematic	47, 55
Tuner Service Corporation	5
Ungar, Div. of Eldon Industries	57
Wayne Electronics	51
Winegard Company	7
Weller-Xcelite Elect. Div.	Cover 3



# no strings attached

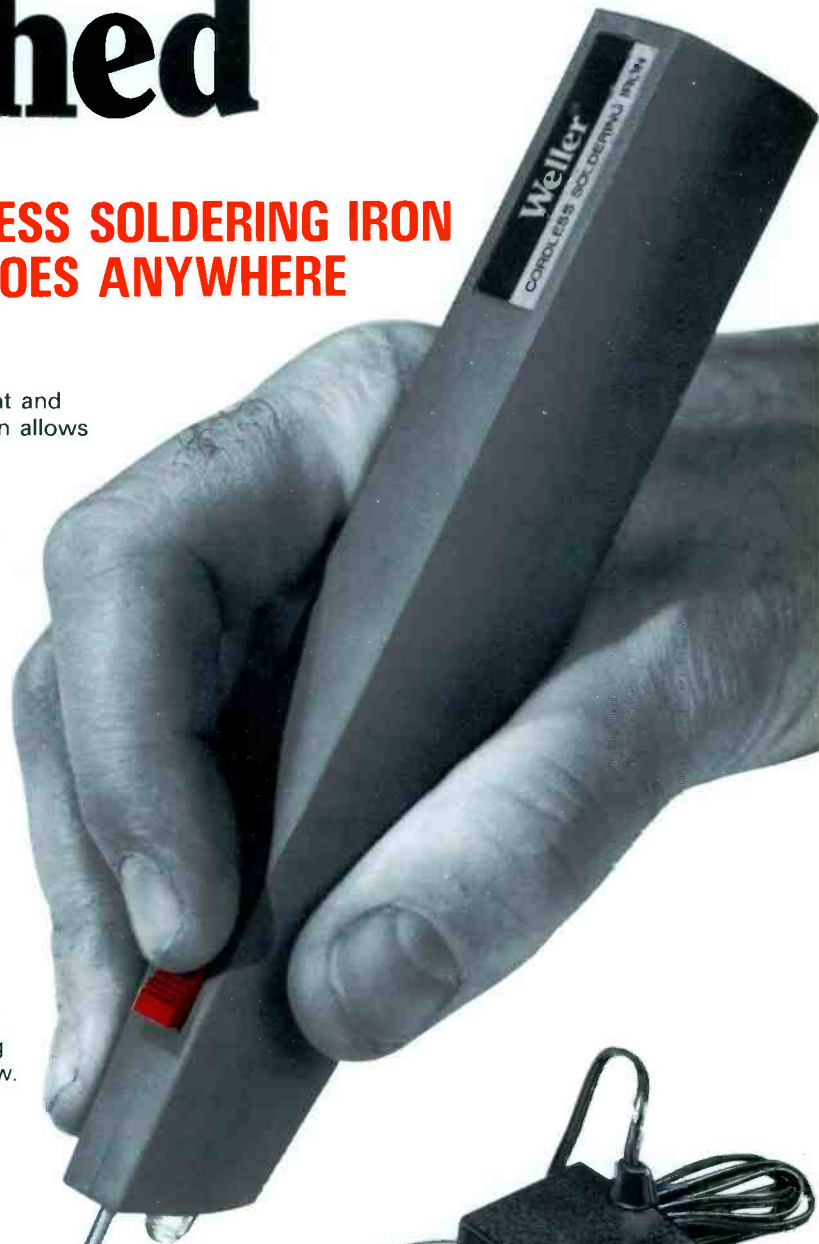
## NEW **Weller**<sup>®</sup> CORDLESS SOLDERING IRON GOES ANYWHERE

A professional quality tool, Weller's feather-light and fingertip-handly WC-100 Cordless Soldering Iron allows you to make connections anywhere...without dependence on an AC cord and outlet.

The heart of the WC-100 is its high-energy, long-life, nickel-cadmium battery which springs into action at the touch of your finger, heating the tip to over 700°F in just 6 seconds. And no danger of accidental discharge. Weller's exclusive sliding safety switch breaks the circuit when your finger is removed, won't lock in "on" position, and does lock in "off" position for added safety while restoring energy with fast-power recharger (UL listed).

Loosen two slotted set screws and you've got instant choice of four tips... regular, long-reach, fine-point, or miniature...each mounted on an extra-strong stainless tube to resist bending. Tip is continuously illuminated by the built-in light which focuses on the work area, a special advantage under poor lighting conditions.

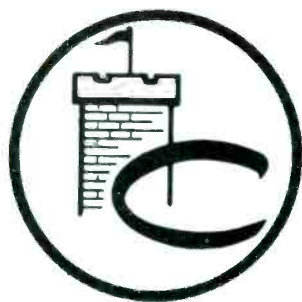
Try this for size! It's a full-scale photo of the compact WC-100. And the real thing is waiting for you at your dealer or distributor...right now. Need to know more? Request literature.



**Weller-Xcelite Electronics Division**  
**The Cooper Group**

P. O. BOX 728, APEX, NORTH CAROLINA 27502

For More Details Circle (1) on Reply Card

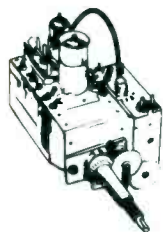


# The Tuner People

*Pioneers of TV Tuner Overhauling  
Originators of Complete TV Tuner Service*

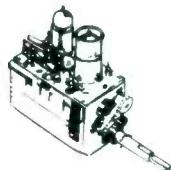
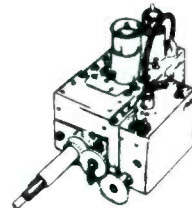
*Castle offers the following services to solve ALL your television tuner problems.*

## Universal Replacements from \$8.95



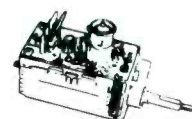
These universal replacement tuners are all equipped with memory fine tuning and uhf position with plug input for uhf tuner. They come complete with hardware and component kit to adapt for use in thousands of popular TV receivers.

STOCK No.	HEATERS	SHAFT		I.F. Snd.	PRICE
		Min.*	Max.*		
CR6P	Parallel 6.3v	1¾"	3"	41.25	8.95
CR7S	Series 600mA	1¾"	3"	41.25	9.50
CR8S	Series 450mA	1¾"	3"	41.25	9.50
CR6XL	Parallel 6.3v	2½"	12"	41.25	10.45
CR7XL	Series 600mA	2½"	12"	41.25	11.00
CR9XL	Series 450mA	2½"	12"	41.25	11.00



## Castle Replacements \$15.95

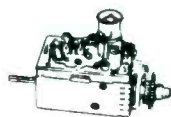
Castle custom replacements made to fit in place of original tuner. Purchase outright . . . no exchange needed. Write for current list of Castle replacements, or request the part number you require (use number on ORIGINAL TUNER ONLY; do not use service literature numbers). Available for many of the popular models of following manufacturers: Admiral, Curtis Mathes, Emerson, GE, Heathkit, Magnavox, Motorola, Muntz, Philco, RCA, Sears, Sylvania, Westinghouse, Zenith and many private labels.



## Overhaul Service \$9.95

*This is the service pioneered by Castle! We are now in our third decade of serving the TV Service Industry*

Service on all makes and models, vhf or uhf, including transistor and color tuners . . . one price \$9.95 Overhaul includes parts, except tubes and transistors.

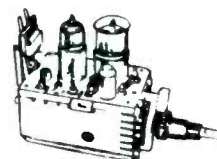


**Remember!**

Castle overhaul service is as near as your post office

Simply send us the defective tuner complete; include tubes, shield cover and any damaged parts with model number and complaint. Your tuner will be expertly overhauled and returned promptly, performance restored, aligned to original standards and warranted for 90 days.

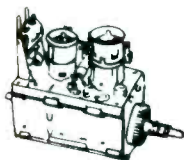
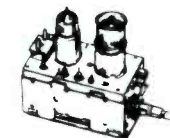
Dismantle tandem uhf and vhf tuners and send in defective unit only. Remove all accessories . . . or dismantling charge will apply.



## Custom Exchange Service \$17.95

When our inspection reveals that original tuner is unfit for overhaul, and it is not available from our stock of outright replacements, we offer to make a custom replacement on exchange basis. Charge for this service is \$15.95 for uhf tuner and \$17.95 for vhf tuner.

If custom replacement cannot be made we will custom rebuild the original tuner at the exchange replacement price.



All replacements are new or rebuilt. All prices are f.o.b. our plant. Add shipping and handling of \$1.25 on all prepaid orders. We will ship C.O.D.

## CASTLE TV TUNER SERVICE, INC.

5701 N. Western Ave., Chicago, Ill. 60645 • Ph. 312-561-6354



For More Details Circle (2) on Reply Card